

TEST REPORT

Application No.: SZEM2306004051AT
Applicant: MYIR Electronics Limited
Address of Applicant: 2/F, Building C, shengjianli Industrial Park, Dafu industrial Zone, Guanlan Street, Longhua District, Shenzhen.
Manufacturer: MYIR Electronics Limited
Address of Manufacturer: 2/F, Building C, shengjianli Industrial Park, Dafu industrial Zone, Guanlan Street, Longhua District, Shenzhen.

Equipment Under Test (EUT):

EUT Name: MYC-YT113X SOM
Model No.: Please refer to section 2 ♣
♣ Please refer to section 2 of this report which indicates which model was actually tested and which were electrically identical.

Standard(s) : EN 55032: 2015+A11:2020+A1:2020
EN 61000-3-3: 2013+ A1:2019+A2:2021
EN IEC 61000-3-2: 2019+A1:2021
EN 55035: 2017+A11:2020

Date of Receipt: 2023-06-25
Date of Test: 2023-06-25 to 2023-06-29
Date of Issue: 2023-07-01

Test Result:	Pass*
---------------------	--------------

* In the configuration tested, the EUT complied with the standards specified above.

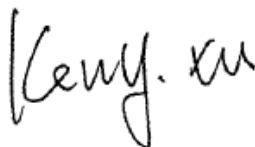

Keny Xu
EMC Laboratory Manager



Revision Record				
Version	Chapter	Date	Modifier	Remark
01		2023-07-01		Original

Authorized for issue by:				
		<i>Foray Chen</i>		
		Foray Chen/Project Engineer		
		<i>Eric Fu</i>		
		Eric Fu/Reviewer		



Unless otherwise agreed in writing, this document is issued by the Company subject to its General Conditions of Service printed overleaf, available on request or accessible at <https://www.sgs.com/en/Terms-and-Conditions>. Attention is drawn to the limitation of liability, indemnification and jurisdiction issues defined therein. Any holder of this document is advised that information contained hereon reflects the Company's findings at the time of its intervention only and within the limits of Client's instructions, if any. The Company's sole responsibility is to its Client and this document does not exonerate parties to a transaction from exercising all their rights and obligations under the transaction documents. This document cannot be reproduced except in full, without prior written approval of the Company. Any unauthorized alteration, forgery or falsification of the content or appearance of this document is unlawful and offenders may be prosecuted to the fullest extent of the law. Unless otherwise stated the results shown in this test report refer only to the sample(s) tested and such sample(s) are retained for 30 days only.

Attention: To check the authenticity of testing /inspection report & certificate, please contact us at telephone: (86-755) 8307 1443, or email: CN.Doccheck@sgs.com

2 Test Summary

Emission Part				
Item	Standard	Method	Requirement	Result
Conducted Emissions at Mains Power Port (150kHz-30MHz)	EN 55032: 2015+A11:2020 +A1:2020	EN 55032: 2015+A11:2020 +A1:2020	Class B	Pass
Radiated Emissions (30MHz-1GHz)		EN 55032: 2015+A11:2020 +A1:2020	Class B	Pass
Radiated Emissions (Above 1GHz)		EN 55032: 2015+A11:2020 +A1:2020	Class B	Pass
Voltage Fluctuations and Flicker	EN 61000-3-3: 2013+ A1:2019 +A2:2021	EN 61000-3-3: 2013+ A1:2019+A2:2021	Clause 5	Pass
Harmonic Current Emission	EN IEC 61000-3-2: 2019+A1:2021	EN IEC 61000-3-2: 2019+A1:2021	N/A	Pass

Immunity Part				
Item	Standard	Method	Requirement	Result
Electrostatic Discharge	EN 55035: 2017+A11:2020	EN 61000-4-2: 2009	± 4kV Contact Discharge; ±2kV, ±4kV, ±8kV Air Discharge	Pass
Radiated Immunity (80MHz-1GHz, 1800MHz, 2600MHz, 3500MHz, 5000MHz)		EN IEC 61000-4-3: 2020	3V/m, 80%, 1kHz Amp. Mod.	Pass
Electrical Fast Transients & Burst at AC Power Port		EN 61000-4-4: 2012	1kV; 5/50ns Tr/Td; 5kHz Repetition Frequency	Pass
Surge at AC Power Port		EN 61000-4-5: 2014 +A1: 2017	1,2/50µs Tr/Td; 1kV Line to Line	Pass
Conducted Immunity at AC Power Port (150kHz-80MHz)		EN 61000-4-6: 2014	0,15 to 10MHz 3Vrms (emf), 10 to 30MHz 3V to 1Vrms(emf), 30 to 80MHz 1Vrms(emf), 80%, 1kHz Amp. Mod.	Pass
Voltage Dips and Interruptions		EN IEC 61000-4-11:2020	<5% residual voltage for 0,5cycle, 70% residual voltage for 25cycles, <5% residual voltage for 250cycles	Pass



Unless otherwise agreed in writing, this document is issued by the Company subject to its General Conditions of Service printed overleaf, available on request or accessible at <https://www.sgs.com/en/Terms-and-Conditions>. Attention is drawn to the limitation of liability, indemnification and jurisdiction issues defined therein. Any holder of this document is advised that information contained herein reflects the Company's findings at the time of its intervention only and within the limits of Client's instructions, if any. The Company's sole responsibility is to its Client and this document does not exonerate parties to a transaction from exercising all their rights and obligations under the transaction documents. This document cannot be reproduced except in full, without prior written approval of the Company. Any unauthorized alteration, forgery or falsification of the content or appearance of this document is unlawful and offenders may be prosecuted to the fullest extent of the law. Unless otherwise stated the results shown in this test report refer only to the sample(s) tested and such sample(s) are retained for 30 days only.

Declaration of EUT Family Grouping:

Model No.: MYC-YT113S3-128N128D-110-I, MYC-YT113S3-128N256D-110-I,
MYC-YT113S3-128N512D-110-I, MYC-YT113S3-128N1D-110-I, MYC-YT113S3-256N128D-110-I,
MYC-YT113S3-256N256D-110-I, MYC-YT113S3-256N512D-110-I, MYC-YT113S3-256N1D-110-I,
MYC-YT113S3-512N128D-110-I, MYC-YT113S3-512N256D-110-I, MYC-YT113S3-512N512D-110-I,
MYC-YT113S3-512N1D-110-I, MYC-YT113S3-1N128D-110-I, MYC-YT113S3-1N256D-110-I,
MYC-YT113S3-1N512D-110-I, MYC-YT113S3-1N1D-110-I, MYC-YT113S3-128N128D-110-C,
MYC-YT113S3-128N256D-110-C, MYC-YT113S3-128N512D-110-C, MYC-YT113S3-128N1D-110-C,
MYC-YT113S3-256N128D-110-C, MYC-YT113S3-256N256D-110-C, MYC-YT113S3-256N512D-110-C,
MYC-YT113S3-256N1D-110-C, MYC-YT113S3-512N128D-110-C, MYC-YT113S3-512N256D-110-C,
MYC-YT113S3-512N512D-110-C, MYC-YT113S3-512N1D-110-C, MYC-YT113S3-1N128D-110-C,
MYC-YT113S3-1N256D-110-C, MYC-YT113S3-1N512D-110-C, MYC-YT113S3-1N1D-110-C,
MYC-YT113S3-4E128D-110-I, MYC-YT113S3-4E256D-110-I, MYC-YT113S3-4E512D-110-I,
MYC-YT113S3-4E1D-110-I, MYC-YT113S3-8E128D-110-I, MYC-YT113S3-8E256D-110-I,
MYC-YT113S3-8E512D-110-I, MYC-YT113S3-8E1D-110-I, MYC-YT113S3-16E128D-110-I,
MYC-YT113S3-16E256D-110-I, MYC-YT113S3-16E512D-110-I, MYC-YT113S3-16E1D-110-I,
MYC-YT113S3-32E128D-110-I, MYC-YT113S3-32E256D-110-I, MYC-YT113S3-32E512D-110-I,
MYC-YT113S3-32E1D-110-I, MYC-YT113S3-4E128D-110-C, MYC-YT113S3-4E256D-110-C,
MYC-YT113S3-4E512D-110-C, MYC-YT113S3-4E1D-110-C, MYC-YT113S3-8E128D-110-C,
MYC-YT113S3-8E256D-110-C, MYC-YT113S3-8E512D-110-C, MYC-YT113S3-8E1D-110-C,
MYC-YT113S3-16E128D-110-C, MYC-YT113S3-16E256D-110-C, MYC-YT113S3-16E512D-110-C,
MYC-YT113S3-16E1D-110-C, MYC-YT113S3-32E128D-110-C, MYC-YT113S3-32E256D-110-C,
MYC-YT113S3-32E512D-110-C, MYC-YT113S3-32E1D-110-C, MYC-YT113S4-128N128D-110-I,
MYC-YT113S4-128N256D-110-I, MYC-YT113S4-128N512D-110-I, MYC-YT113S4-128N1D-110-I,
MYC-YT113S4-256N128D-110-I, MYC-YT113S4-256N256D-110-I, MYC-YT113S4-256N512D-110-I,
MYC-YT113S4-256N1D-110-I, MYC-YT113S4-512N128D-110-I, MYC-YT113S4-512N256D-110-I,
MYC-YT113S4-512N512D-110-I, MYC-YT113S4-512N1D-110-I, MYC-YT113S4-1N128D-110-I,
MYC-YT113S4-1N256D-110-I, MYC-YT113S4-1N512D-110-I, MYC-YT113S4-1N1D-110-I,
MYC-YT113S4-4E128D-110-I, MYC-YT113S4-4E256D-110-I, MYC-YT113S4-4E512D-110-I,
MYC-YT113S4-4E1D-110-I, MYC-YT113S4-8E128D-110-I, MYC-YT113S4-8E256D-110-I,
MYC-YT113S4-8E512D-110-I, MYC-YT113S4-8E1D-110-I, MYC-YT113S4-16E128D-110-I,



Unless otherwise agreed in writing, this document is issued by the Company subject to its General Conditions of Service printed overleaf, available on request or accessible at <https://www.sgs.com/en/Terms-and-Conditions>. Attention is drawn to the limitation of liability, indemnification and jurisdiction issues defined therein. Any holder of this document is advised that information contained hereon reflects the Company's findings at the time of its intervention only and within the limits of Client's instructions, if any. The Company's sole responsibility is to its Client and this document does not exonerate parties to a transaction from exercising all their rights and obligations under the transaction documents. This document cannot be reproduced except in full, without prior written approval of the Company. Any unauthorized alteration, forgery or falsification of the content or appearance of this document is unlawful and offenders may be prosecuted to the fullest extent of the law. Unless otherwise stated the results shown in this test report refer only to the sample(s) tested and such sample(s) are retained for 30 days only.

Attention: To check the authenticity of testing /inspection report & certificate, please contact us at telephone: (86-755) 8307 1443, or email: CN.Doccheck@sgs.com

SGS-CSTC Standards Technical Services Co., Ltd. Shenzhen Branch

SZEMC-TRF-01 Rev. A/0 Aug01,2022

Report No.: SZEM230600405101

Page: 5 of 64

MYC-YT113S4-16E256D-110-I, MYC-YT113S4-16E512D-110-I, MYC-YT113S4-16E1D-110-I,
MYC-YT113S4-32E128D-110-I, MYC-YT113S4-32E256D-110-I, MYC-YT113S4-32E512D-110-I,
MYC-YT113S4-32E1D-110-I, MYC-YT113S4-128N128D-110-C, MYC-YT113S4-128N256D-110-C,
MYC-YT113S4-128N512D-110-C, MYC-YT113S4-128N1D-110-C, MYC-YT113S4-256N128D-110-C,
MYC-YT113S4-256N256D-110-C, MYC-YT113S4-256N512D-110-C, MYC-YT113S4-256N1D-110-C,
MYC-YT113S4-512N128D-110-C, MYC-YT113S4-512N256D-110-C, MYC-YT113S4-512N512D-110-C,
MYC-YT113S4-512N1D-110-C, MYC-YT113S4-1N128D-110-C, MYC-YT113S4-1N256D-110-C,
MYC-YT113S4-1N512D-110-C, MYC-YT113S4-1N1D-110-C, MYC-YT113S4-4E128D-110-C,
MYC-YT113S4-4E256D-110-C, MYC-YT113S4-4E512D-110-C, MYC-YT113S4-4E1D-110-C,
MYC-YT113S4-8E128D-110-C, MYC-YT113S4-8E256D-110-C, MYC-YT113S4-8E512D-110-C,
MYC-YT113S4-8E1D-110-C, MYC-YT113S4-16E128D-110-C, MYC-YT113S4-16E256D-110-C,
MYC-YT113S4-16E512D-110-C, MYC-YT113S4-16E1D-110-C, MYC-YT113S4-32E128D-110-C,
MYC-YT113S4-32E256D-110-C, MYC-YT113S4-32E512D-110-C, MYC-YT113S4-32E1D-110-C

Only the model MYC-YT113S3-256N128D-110-I was tested, since according to the declaration from the applicant, the electrical circuit design, PCB layout, components used and internal wiring and functions were identical for the above models, with only difference being of DDR memory size, Nand Flash Size, eMMC Flash Size.



Unless otherwise agreed in writing, this document is issued by the Company subject to its General Conditions of Service printed overleaf, available on request or accessible at <https://www.sgs.com/en/Terms-and-Conditions>. Attention is drawn to the limitation of liability, indemnification and jurisdiction issues defined therein. Any holder of this document is advised that information contained hereon reflects the Company's findings at the time of its intervention only and within the limits of Client's instructions, if any. The Company's sole responsibility is to its Client and this document does not exonerate parties to a transaction from exercising all their rights and obligations under the transaction documents. This document cannot be reproduced except in full, without prior written approval of the Company. Any unauthorized alteration, forgery or falsification of the content or appearance of this document is unlawful and offenders may be prosecuted to the fullest extent of the law. Unless otherwise stated the results shown in this test report refer only to the sample(s) tested and such sample(s) are retained for 30 days only.

Attention: To check the authenticity of testing /inspection report & certificate, please contact us at telephone: (86-755) 8307 1443, or email: CN.Doccheck@sgs.com

3 Contents

	Page
1 Cover Page	1
2 Test Summary	3
3 Contents.....	6
4 General Information.....	8
4.1 Details of E.U.T.	8
4.2 Description of Support Units.....	8
4.3 Measurement Uncertainty	8
4.4 Test Location	9
4.5 Test Facility	9
4.6 Deviation from Standards.....	9
4.7 Abnormalities from Standard Conditions	9
4.8 EMS Monitor.....	9
5 Equipment List.....	10
6 Emission Test Results.....	13
6.1 Conducted Emissions at Mains Power Port (150kHz-30MHz)	13
6.1.1 E.U.T. Operation	13
6.1.2 Test Mode Description	13
6.1.3 Test Setup Diagram	13
6.1.4 Measurement Procedure and Data.....	13
6.2 Radiated Emissions (30MHz-1GHz).....	16
6.2.1 E.U.T. Operation	16
6.2.2 Test Mode Description	16
6.2.3 Test Setup Diagram	16
6.2.4 Measurement Procedure and Data.....	17
6.3 Radiated Emissions (Above 1GHz).....	20
6.3.1 E.U.T. Operation	20
6.3.2 Test Mode Description	20
6.3.3 Test Setup Diagram	20
6.3.4 Measurement Procedure and Data.....	21
6.4 Voltage Fluctuations and Flicker	24
6.4.1 E.U.T. Operation	24
6.4.2 Test Mode Description	24
6.4.3 Test Setup Diagram	24
6.4.4 Measurement Procedure and Data.....	24
6.5 Harmonic Current Emission.....	26
6.5.1 Conclusion	26
7 Immunity Test Results.....	27
7.1 Electrostatic Discharge.....	44
7.1.1 Test Setup Diagram	44



SGS-CSTC Standards Technical Services Co., Ltd. Shenzhen Branch

SZEMC-TRF-01 Rev. A/0 Aug01,2022

Report No.: SZEM230600405101

Page: 7 of 64

7.1.2	E.U.T. Operation	44
7.1.3	Test Mode Description	44
7.1.4	Test Condition and Results:	44
7.2	Radiated Immunity (80MHz-1GHz,1800MHz,2600MHz,3500MHz,5000MHz).....	46
7.2.1	Test Setup Diagram	46
7.2.2	E.U.T. Operation	46
7.2.3	Test Mode Description	46
7.2.4	Test Condition and Results:	46
7.3	Electrical Fast Transients & Burst at AC Power Port.....	48
7.3.1	Test Setup Diagram	48
7.3.2	E.U.T. Operation	48
7.3.3	Test Mode Description	48
7.3.4	Test Condition and Results:	48
7.4	Surge at AC Power Port	49
7.4.1	Test Setup Diagram	49
7.4.2	E.U.T. Operation	49
7.4.3	Test Mode Description	49
7.4.4	Test Condition and Results:	49
7.5	Conducted Immunity at AC Power Port (150kHz-80MHz).....	51
7.5.1	Test Setup Diagram	51
7.5.2	E.U.T. Operation	51
7.5.3	Test Mode Description	51
7.5.4	Test Condition and Results:	51
7.6	Voltage Dips and Interruptions	53
7.6.1	Test Setup Diagram	53
7.6.2	E.U.T. Operation	53
7.6.3	Test Mode Description	53
7.6.4	Test Condition and Results:	53
8	Test Setup Photo.....	55
9	EUT Constructional Details (EUT Photos).....	60



4 General Information

4.1 Details of E.U.T.

Power supply:	DC5V 2A
---------------	---------

Remark: The information in this section is provided by the applicant or manufacturer, SGS is not liable to the accuracy, suitability, reliability or/and integrity of the information.

4.2 Description of Support Units

Description	Manufacturer	Model No.	Serial No.
Test board	MYIR	MYB-YT113X	V10
Adapter	NETGEAR	MU42-3120350	REF. No.SEA05D14G

4.3 Measurement Uncertainty

Test Item	Measurement Uncertainty
Conducted Emissions at Mains Power Port (150kHz-30MHz)	± 3.1dB
Radiated Emissions (30MHz-1GHz)	± 6.0dB for 3m; ± 5.0dB for 10m
Radiated Emissions (Above 1GHz)	± 4.6dB
Voltage Fluctuations and Flicker	± 4.2%
Harmonic Current Emission	± 4.2%
Electrostatic Discharge	± 6%
Radiated Immunity (80MHz-1GHz,1800MHz,2600MHz,3500MHz,5000MHz)	± 2.1dB
Electrical Fast Transients & Burst at AC Power Port	± 5.5%
Surge at AC Power Port	± 5.5%
Conducted Immunity at AC Power Port (150kHz-80MHz)	± 1.5dB
Voltage Dips and Interruptions	± 3.7%

Remark:

The U_{lab} (lab Uncertainty) is less than $U_{CISPR/ETSI}$ (CISPR/ETSI Uncertainty), so the test results

- compliance is deemed to occur if no measured disturbance level exceeds the disturbance limit;
- non-compliance is deemed to occur if any measured disturbance level exceeds the disturbance limit.



4.4 Test Location

All tests were performed at:

SGS-CSTC Standards Technical Services Co., Ltd., Shenzhen Branch

No. 1 Workshop, M-10, Middle Section, Science & Technology Park, Nanshan District, Shenzhen, Guangdong, China. 518057.

Tel: +86 755 2601 2053 Fax: +86 755 2671 0594

No tests were sub-contracted.

4.5 Test Facility

The test facility is recognized, certified, or accredited by the following organizations:

• **A2LA (Certificate No. 3816.01)**

SGS-CSTC Standards Technical Services Co., Ltd., Shenzhen EMC Laboratory is accredited by the American Association for Laboratory Accreditation(A2LA). Certificate No. 3816.01.

• **VCCI (Member No. 1937)**

The 3m Fully-anechoic chamber for above 1GHz, 10m Semi-anechoic chamber for below 1GHz, Shielded Room for Mains Port Conducted Interference Measurement and Telecommunication Port Conducted Interference Measurement of SGS-CSTC Standards Technical Services Co., Ltd. Shenzhen EMC laboratory have been registered in accordance with the Regulations for Voluntary Control Measures with Registration No.: G-20026, R-14188, C-12383 and T-11153 respectively.

• **FCC –Designation Number: CN1336**

SGS-CSTC Standards Technical Services Co., Ltd., Shenzhen EMC Laboratory has been recognized as an accredited testing laboratory.

Designation Number: CN1336. Test Firm Registration Number: 787754.

• **Innovation, Science and Economic Development Canada**

SGS-CSTC Standards Technical Services Co., Ltd., Shenzhen EMC Laboratory has been recognized by ISED as an accredited testing laboratory.

CAB identifier: CN0006.

IC#: 4620C.

4.6 Deviation from Standards

None

4.7 Abnormalities from Standard Conditions

None

4.8 EMS Monitor

Visual: Monitored the work status of the EUT

Audio: None



5 Equipment List

Conducted Emissions at Mains Power Port (150kHz-30MHz)					
Equipment	Manufacturer	Model No.	Inventory No.	Cal Date	Cal Due Date
Shielding Room	ZhongYu Electron	GB-88	SEM001-06	2022-05-14	2025-05-13
EMI Test Receiver	Rohde&Schwarz	ESCI	SEM004-02	2023-03-20	2024-03-19
Measurement Software	AUDIX	e3 V8.2014-6-27a	N/A	N/A	N/A
Coaxial Cable	SGS	N/A	SEM024-01	2022-07-08	2023-07-07
LISN	Rohde&Schwarz	ENV216	SEM007-01	2022-09-20	2023-09-19
LISN	ETS-LINDGREN	3816/2	SEM007-02	2023-03-20	2024-03-19

Radiated Emissions (30MHz-1GHz)					
Equipment	Manufacturer	Model No.	Inventory No.	Cal Date	Cal Due Date
3m Semi-Anechoic Chamber	ETS-LINDGREN	N/A	SEM001-01	2020-07-19	2023-07-18
MXE EMI Receiver	Agilent Technologies	N9038A	SEM004-15	2022-10-20	2023-10-19
BiConiLog Antenna	ETS-LINDGREN	3142C	SEM003-01	2021-09-17	2023-09-16
Pre-Amplifier	Agilent Technologies	8447D	SEM005-01	2023-03-20	2024-03-19
Measurement Software	AUDIX	e3 V8.2014-6-27	N/A	N/A	N/A
Coaxial Cable	SGS	N/A	SEM025-01	2022-07-08	2023-07-07

Radiated Emissions (Above 1GHz)					
Equipment	Manufacturer	Model No.	Inventory No.	Cal Date	Cal Due Date
3m Semi-Anechoic Chamber	AUDIX	N/A	SEM001-02	2022-04-02	2025-04-01
Signal Analyzer	Rohde & Schwarz	FSV40	SEM008-04	2023-03-20	2024-03-19
Horn Antenna	Rohde&Schwarz	HF907	SEM003-07	2022-07-24	2024-07-23
Microwave system amplifier	Agilent	83017A	SEM005-25	2022-09-21	2023-09-20
Measurement Software	AUDIX	e3 V8.2014-6-27	N/A	N/A	N/A
Coaxial Cable	SGS	N/A	SEM026-01	2022-07-08	2023-07-07

Voltage Fluctuations and Flicker					
Equipment	Manufacturer	Model No.	Inventory No.	Cal Date	Cal Due Date
AC Power Source	California Instruments	5001ix	SEM016-02	2022-10-20	2023-10-19
Power Analyzer	California Instruments	PACS-1	SEM016-01	2022-10-20	2023-10-19
Measurement Software	California Instruments	CTS 4.0 V4.29.0	N/A	N/A	N/A



Unless otherwise agreed in writing, this document is issued by the Company subject to its General Conditions of Service printed overleaf, available on request or accessible at <https://www.sgs.com/en/Terms-and-Conditions>. Attention is drawn to the limitation of liability, indemnification and jurisdiction issues defined therein. Any holder of this document is advised that information contained hereon reflects the Company's findings at the time of its intervention only and within the limits of Client's instructions, if any. The Company's sole responsibility is to its Client and this document does not exonerate parties to a transaction from exercising all their rights and obligations under the transaction documents. This document cannot be reproduced except in full, without prior written approval of the Company. Any unauthorized alteration, forgery or falsification of the content or appearance of this document is unlawful and offenders may be prosecuted to the fullest extent of the law. Unless otherwise stated the results shown in this test report refer only to the sample(s) tested and such sample(s) are retained for 30 days only.

Attention: To check the authenticity of testing /inspection report & certificate, please contact us at telephone: (86-755) 8307 1443, or email: CN.Doccheck@sgs.com

SGS-CSTC Standards Technical Services Co., Ltd. Shenzhen Branch

SZEMC-TRF-01 Rev. A/0 Aug01,2022

Report No.: SZEM230600405101

Page: 11 of 64

Electrostatic Discharge					
Equipment	Manufacturer	Model No.	Inventory No.	Cal Date	Cal Due Date
ESD Generator	TESEQ AG	NSG 437	SEM019-02	2023-03-22	2024-03-21

Radiated Immunity (80MHz-1GHz,1800MHz,2600MHz,3500MHz,5000MHz)					
Equipment	Manufacturer	Model No.	Inventory No.	Cal Date	Cal Due Date
Fully-Anechoic Chamber 2	Chang Zhou Zhong Shuo	854	SEM001-05	2020-07-19	2023-07-18
Power Sensor	Rohde & Schwarz	NRP-Z91	SEM009-09	2023-03-21	2024-03-20
Stacked Log.-Per.-Broadband Antenna	Schwarzbeck	STLP 9129	SEM003-25	N/A	N/A
Signal Generator	Rohde & Schwarz	SMB100A	SEM006-11	2023-03-21	2024-03-20
Broadband Amplifier	Rohde & Schwarz	BBA150-BC250	SEM005-12	2022-09-21	2023-09-20
Broadband Amplifier	Rohde & Schwarz	BBA150-D110	SEM005-13	2023-03-21	2024-03-20
Broadband Amplifier	Rohde & Schwarz	BBA150-E60	SEM005-16	2023-03-21	2024-03-20
Measurement Software	Rohde & Schwarz	EMC32 V9.25.00	N/A	N/A	N/A

Electrical Fast Transients & Burst at AC Power Port					
Equipment	Manufacturer	Model No.	Inventory No.	Cal Date	Cal Due Date
Ultra Compact Simulator	EM Test	UCS 500N7	SEM018-02	2023-03-20	2024-03-19

Surge at AC Power Port					
Equipment	Manufacturer	Model No.	Inventory No.	Cal Date	Cal Due Date
Ultra Compact Simulator	EM Test	UCS 500N7	SEM018-02	2023-03-20	2024-03-19

Conducted Immunity at AC Power Port (150kHz-80MHz)					
Equipment	Manufacturer	Model No.	Inventory No.	Cal Date	Cal Due Date
Shielding Room	TST PASS	N/A	SEM001-17	2021-11-22	2024-11-21
RF-Generator	SCHAFFNER	NSG 2070	SEM006-01	2022-10-20	2023-10-19
Coupling/Decoupling Network	SCHAFFNER	CDN M016	SEM007-03	2023-03-31	2024-03-30

Voltage Dips and Interruptions					
Equipment	Manufacturer	Model No.	Inventory No.	Cal Date	Cal Due Date
Ultra Compact Simulator	EM Test	UCS 500N7	SEM018-02	2023-03-20	2024-03-19



Unless otherwise agreed in writing, this document is issued by the Company subject to its General Conditions of Service printed overleaf, available on request or accessible at <https://www.sgs.com/en/Terms-and-Conditions>. Attention is drawn to the limitation of liability, indemnification and jurisdiction issues defined therein. Any holder of this document is advised that information contained hereon reflects the Company's findings at the time of its intervention only and within the limits of Client's instructions, if any. The Company's sole responsibility is to its Client and this document does not exonerate parties to a transaction from exercising all their rights and obligations under the transaction documents. This document cannot be reproduced except in full, without prior written approval of the Company. Any unauthorized alteration, forgery or falsification of the content or appearance of this document is unlawful and offenders may be prosecuted to the fullest extent of the law. Unless otherwise stated the results shown in this test report refer only to the sample(s) tested and such sample(s) are retained for 30 days only.

SGS-CSTC Standards Technical Services Co., Ltd. Shenzhen Branch

SZEMC-TRF-01 Rev. A/0 Aug01,2022

Report No.: SZEM230600405101

Page: 12 of 64

General used equipment					
Equipment	Manufacturer	Model No.	Inventory No.	Cal Date	Cal Due Date
Humidity/ Temperature Indicator	Mingle	N/A	SEM002-08	2022-09-04	2023-09-03
Humidity/ Temperature Indicator	Anymetre	TH101B	SEM002-09	2022-09-04	2023-09-03
Barometer	Changchun Meteorological Industry Factory	DYM3	SEM002-01	2023-03-23	2024-03-22



Unless otherwise agreed in writing, this document is issued by the Company subject to its General Conditions of Service printed overleaf, available on request or accessible at <https://www.sgs.com/en/Terms-and-Conditions>. Attention is drawn to the limitation of liability, indemnification and jurisdiction issues defined therein. Any holder of this document is advised that information contained hereon reflects the Company's findings at the time of its intervention only and within the limits of Client's instructions, if any. The Company's sole responsibility is to its Client and this document does not exonerate parties to a transaction from exercising all their rights and obligations under the transaction documents. This document cannot be reproduced except in full, without prior written approval of the Company. Any unauthorized alteration, forgery or falsification of the content or appearance of this document is unlawful and offenders may be prosecuted to the fullest extent of the law. Unless otherwise stated the results shown in this test report refer only to the sample(s) tested and such sample(s) are retained for 30 days only.

Attention: To check the authenticity of testing /inspection report & certificate, please contact us at telephone: (86-755) 8307 1443, or email: CN.Doccheck@sgs.com

6 Emission Test Results

6.1 Conducted Emissions at Mains Power Port (150kHz-30MHz)

Test Requirement: EN 55032: 2015+A11:2020+A1:2020

Test Method: EN 55032: 2015+A11:2020+A1:2020

Limit:

0.15MHz-0.5MHz 66dB(μV)-56dB(μV) quasi-peak, 56dB(μV)-46dB(μV) average

0.5MHz-5MHz 56dB(μV) quasi-peak, 46dB(μV) average

5MHz-30MHz 60dB(μV) quasi-peak, 50dB(μV) average

Detector: Peak for pre-scan (9kHz resolution bandwidth) 0.15MHz to 30MHz

6.1.1 E.U.T. Operation

Operating Environment:

Temperature: 23.8 °C Humidity: 43.9 % RH Atmospheric Pressure: 1005 mbar

6.1.2 Test Mode Description

Pre-scan / Final test	Mode Code	Description
Final test	00	On mode, keep EUT working normally with test board.

6.1.3 Test Setup Diagram

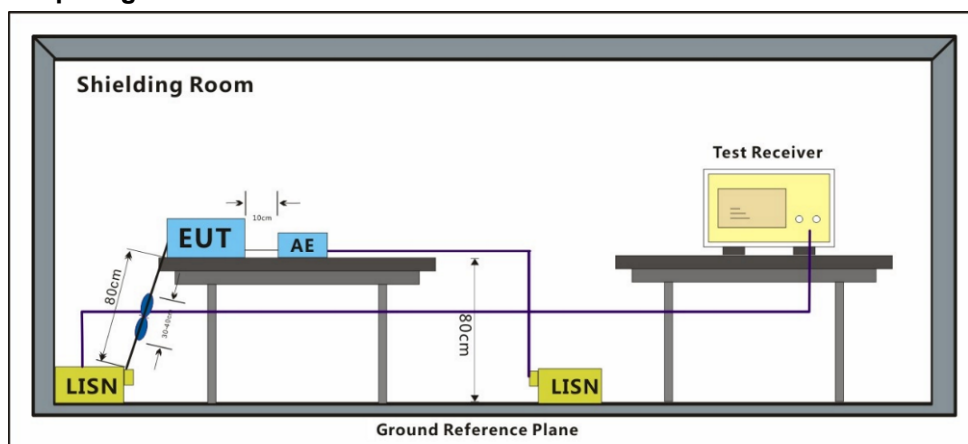

6.1.4 Measurement Procedure and Data

An initial pre-scan was performed with peak detector. Quasi-Peak or Average measurement were performed at the frequencies with maximized peak emission were detected.

Remark: Level= Read Level+ Cable Loss+ LISN Factor



Test Mode: 00; Line: Live line

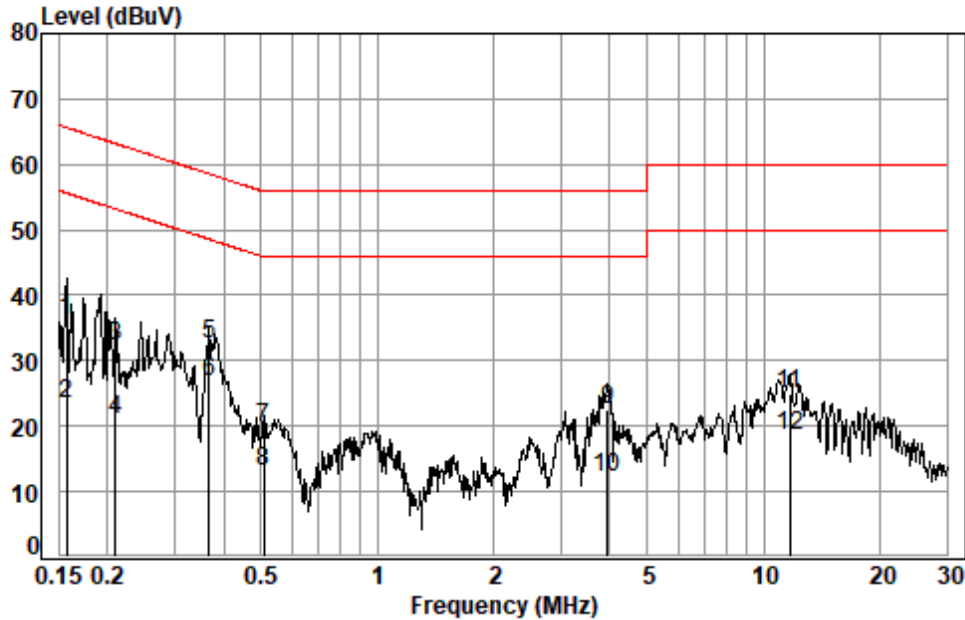

Site : Shielding Room
 Condition: Line
 Job No. : 04051AT
 Test mode: 00

	Freq	Cable Loss	LISN Factor	Read Level	Level	Limit Line	Over Limit	Remark
	MHz	dB	dB	dBuV	dBuV	dBuV	dB	
1	0.1573	0.03	9.76	26.45	36.24	65.60	-29.36	QP
2	0.1573	0.03	9.76	13.56	23.35	55.60	-32.25	Average
3	0.2094	0.04	9.76	22.39	32.19	63.23	-31.04	QP
4	0.2094	0.04	9.76	11.14	20.94	53.23	-32.29	Average
5 *	0.3673	0.05	9.76	22.86	32.67	58.56	-25.89	QP
6 *	0.3673	0.05	9.76	17.00	26.81	48.56	-21.75	Average
7	0.5074	0.06	9.76	9.88	19.70	56.00	-36.30	QP
8	0.5074	0.06	9.76	3.14	12.96	46.00	-33.04	Average
9	3.9430	0.14	9.87	12.58	22.59	56.00	-33.41	QP
10	3.9430	0.14	9.87	2.17	12.18	46.00	-33.82	Average
11	11.6826	0.18	10.38	14.31	24.87	60.00	-35.13	QP
12	11.6826	0.18	10.38	8.10	18.66	50.00	-31.34	Average



Unless otherwise agreed in writing, this document is issued by the Company subject to its General Conditions of Service printed overleaf, available on request or accessible at <https://www.sgs.com/en/Terms-and-Conditions>. Attention is drawn to the limitation of liability, indemnification and jurisdiction issues defined therein. Any holder of this document is advised that information contained hereon reflects the Company's findings at the time of its intervention only and within the limits of Client's instructions, if any. The Company's sole responsibility is to its Client and this document does not exonerate parties to a transaction from exercising all their rights and obligations under the transaction documents. This document cannot be reproduced except in full, without prior written approval of the Company. Any unauthorized alteration, forgery or falsification of the content or appearance of this document is unlawful and offenders may be prosecuted to the fullest extent of the law. Unless otherwise stated the results shown in this test report refer only to the sample(s) tested and such sample(s) are retained for 30 days only.
 Attention: To check the authenticity of testing /inspection report & certificate, please contact us at telephone: (86-755) 8307 1443, or email: CN.Doccheck@sgs.com
 No.1 Workshop, M-10, Middle Section, Science & Technology Park, Nanshan District, Shenzhen, Guangdong, China 518057 t (86-755) 26012053 f (86-755) 26710594 www.sgs.com.cn
 中国·广东·深圳市南山区科技园中区M-10栋1号厂房 邮编: 518057 t (86-755) 26012053 f (86-755) 26710594 sgs.china@sgs.com

Test Mode: 00; Line: Neutral Line

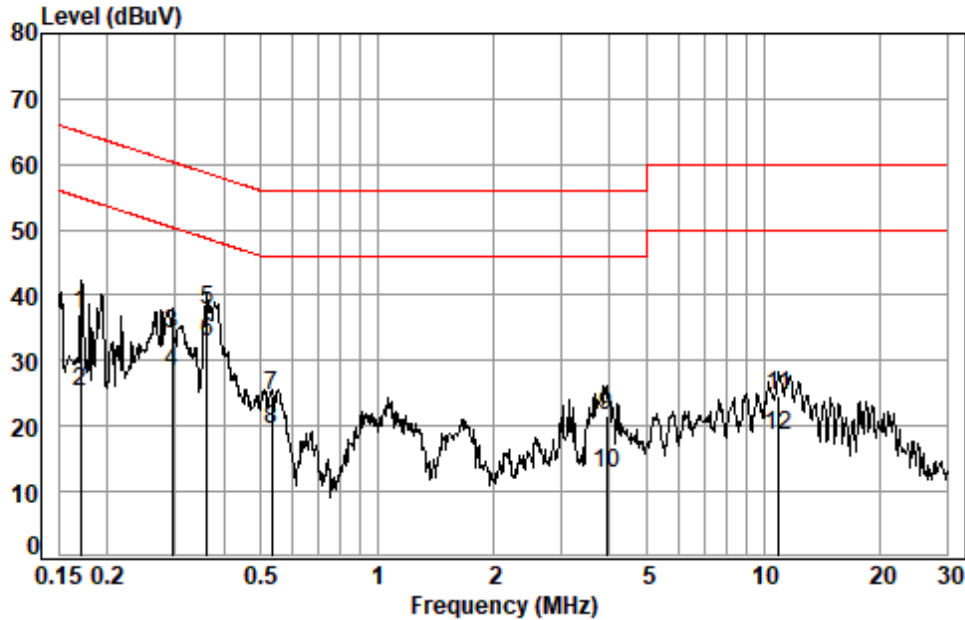

Site : Shielding Room
 Condition: Neutral
 Job No. : 04051AT
 Test mode: 00

	Freq	Cable Loss	LISN Factor	Read Level	Limit Level	Limit Line	Over Limit	Remark
	MHz	dB	dB	dBuV	dBuV	dBuV	dB	
1	0.1703	0.03	9.73	27.20	36.96	64.94	-27.98	QP
2	0.1703	0.03	9.73	15.53	25.29	54.94	-29.65	Average
3	0.2940	0.04	9.73	24.21	33.98	60.41	-26.43	QP
4	0.2940	0.04	9.73	18.40	28.17	50.41	-22.24	Average
5 *	0.3634	0.05	9.74	27.89	37.68	58.65	-20.97	QP
6 *	0.3634	0.05	9.74	23.19	32.98	48.65	-15.67	Average
7	0.5322	0.06	9.74	14.78	24.58	56.00	-31.42	QP
8	0.5322	0.06	9.74	9.62	19.42	46.00	-26.58	Average
9	3.9222	0.14	9.87	11.46	21.47	56.00	-34.53	QP
10	3.9222	0.14	9.87	2.74	12.75	46.00	-33.25	Average
11	10.9629	0.19	10.39	13.98	24.56	60.00	-35.44	QP
12	10.9629	0.19	10.39	7.95	18.53	50.00	-31.47	Average



Unless otherwise agreed in writing, this document is issued by the Company subject to its General Conditions of Service printed overleaf, available on request or accessible at <https://www.sgs.com/en/Terms-and-Conditions>. Attention is drawn to the limitation of liability, indemnification and jurisdiction issues defined therein. Any holder of this document is advised that information contained hereon reflects the Company's findings at the time of its intervention only and within the limits of Client's instructions, if any. The Company's sole responsibility is to its Client and this document does not exonerate parties to a transaction from exercising all their rights and obligations under the transaction documents. This document cannot be reproduced except in full, without prior written approval of the Company. Any unauthorized alteration, forgery or falsification of the content or appearance of this document is unlawful and offenders may be prosecuted to the fullest extent of the law. Unless otherwise stated the results shown in this test report refer only to the sample(s) tested and such sample(s) are retained for 30 days only.
 Attention: To check the authenticity of testing /inspection report & certificate, please contact us at telephone: (86-755) 8307 1443, or email: CN.Doccheck@sgs.com
 No.1 Workshop, M-10, Middle Section, Science & Technology Park, Nanshan District, Shenzhen, Guangdong, China 518057 t (86-755) 26012053 f (86-755) 26710594 www.sgs.com.cn
 中国·广东·深圳市南山区科技园中区M-10栋1号厂房 邮编: 518057 t (86-755) 26012053 f (86-755) 26710594 sgs.china@sgs.com

6.2 Radiated Emissions (30MHz-1GHz)

Test Requirement: EN 55032: 2015+A11:2020+A1:2020

Test Method: EN 55032: 2015+A11:2020+A1:2020

Measurement Distance: 3m

Limit:

FREQUENCY (MHz)	dBuV/m (At 10m)	dBuV/m (At 3m)
	Class B	Class B
30 ~ 230	30	40
230 ~ 1000	37	47
Detector: Peak for pre-scan (120kHz resolution bandwidth) 30MHz to 1000MHz		

6.2.1 E.U.T. Operation

Operating Environment:

Temperature: 22.1 °C

Humidity: 41.2 % RH

Atmospheric Pressure: 1005 mbar

6.2.2 Test Mode Description

Pre-scan / Final test	Mode Code	Description
Final test	00	On mode, keep EUT working normally with test board.

6.2.3 Test Setup Diagram

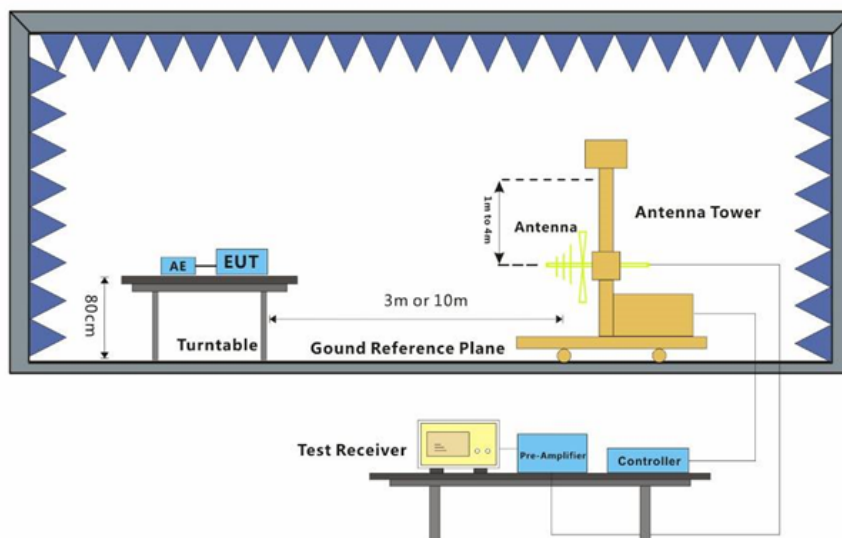

Unless otherwise agreed in writing, this document is issued by the Company subject to its General Conditions of Service printed overleaf, available on request or accessible at <https://www.sgs.com/en/Terms-and-Conditions>. Attention is drawn to the limitation of liability, indemnification and jurisdiction issues defined therein. Any holder of this document is advised that information contained hereon reflects the Company's findings at the time of its intervention only and within the limits of Client's instructions, if any. The Company's sole responsibility is to its Client and this document does not exonerate parties to a transaction from exercising all their rights and obligations under the transaction documents. This document cannot be reproduced except in full, without prior written approval of the Company. Any unauthorized alteration, forgery or falsification of the content or appearance of this document is unlawful and offenders may be prosecuted to the fullest extent of the law. Unless otherwise stated the results shown in this test report refer only to the sample(s) tested and such sample(s) are retained for 30 days only.

6.2.4 Measurement Procedure and Data

Frequency range: 30MHz-1GHz

An initial pre-scan was performed in the chamber using the spectrum analyser in peak detection mode. Quasi-peak measurements were conducted based on the peak sweep graph. The EUT was measured by BiConiLog antenna with 2 orthogonal polarities.

The red line show in graphic is the limit in standard used in this section.

Level=Read Level + Antenna Factor + Cable Loss - Preamp Factor



Test Mode: 00; Polarity: Horizontal

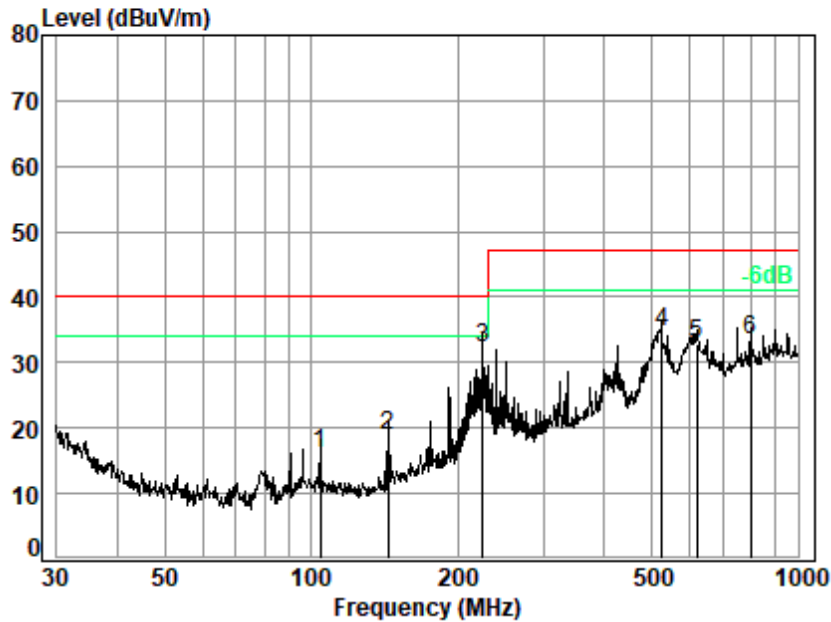

Site : chamber
 Condition: 3m HORIZONTAL
 Job No. : 04051AT
 Test Mode: 00

	Ant Freq	Cable Factor	Preamp Loss	Read Level	Limit Level	Over Line	Remark
	MHz	dB/m	dB	dBuV	dBuV/m	dBuV/m	dB
1	104.17	12.96	1.16	26.98	29.13	40.00	-23.73 QP
2	143.83	12.25	1.38	26.82	32.18	40.00	-21.01 QP
3 q	225.31	16.36	1.80	26.50	40.57	40.00	-7.77 QP
4	524.55	24.09	2.89	26.87	34.49	47.00	-12.40 QP
5	618.54	25.78	3.18	27.03	31.06	47.00	-14.01 QP
6	798.98	26.96	3.66	26.30	29.00	47.00	-13.68 QP



Unless otherwise agreed in writing, this document is issued by the Company subject to its General Conditions of Service printed overleaf, available on request or accessible at <https://www.sgs.com/en/Terms-and-Conditions>. Attention is drawn to the limitation of liability, indemnification and jurisdiction issues defined therein. Any holder of this document is advised that information contained hereon reflects the Company's findings at the time of its intervention only and within the limits of Client's instructions, if any. The Company's sole responsibility is to its Client and this document does not exonerate parties to a transaction from exercising all their rights and obligations under the transaction documents. This document cannot be reproduced except in full, without prior written approval of the Company. Any unauthorized alteration, forgery or falsification of the content or appearance of this document is unlawful and offenders may be prosecuted to the fullest extent of the law. Unless otherwise stated the results shown in this test report refer only to the sample(s) tested and such sample(s) are retained for 30 days only.

Attention: To check the authenticity of testing /inspection report & certificate, please contact us at telephone: (86-755) 8307 1443, or email: CN.Doccheck@sgs.com

Test Mode: 00; Polarity: Vertical

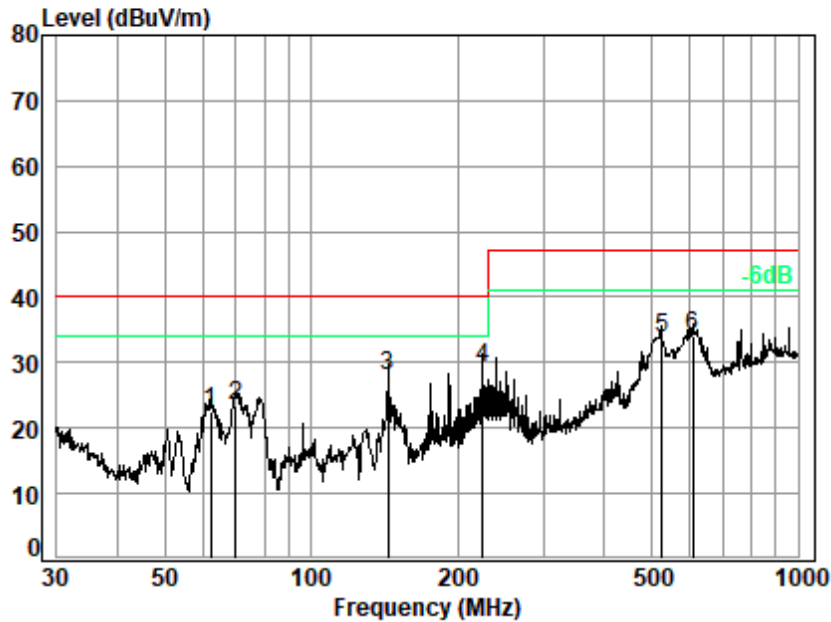

Site : chamber
 Condition: 3m VERTICAL
 Job No. : 04051AT
 Test Mode: 00

	Ant Freq	Cable Factor	Preamp Loss	Read Level	Limit Level	Over Line	Remark
	MHz	dB/m	dB	dBuV	dBuV/m	dBuV/m	dB
1	62.21	10.95	0.87	27.13	37.81	22.50	40.00 -17.50 QP
2	70.09	10.34	0.94	27.10	39.17	23.35	40.00 -16.65 QP
3	143.83	12.25	1.38	26.82	41.12	27.93	40.00 -12.07 QP
4 q	225.31	16.36	1.80	26.50	37.66	29.32	40.00 -10.68 QP
5	524.55	24.09	2.89	26.87	33.52	33.63	47.00 -13.37 QP
6	607.79	25.62	3.14	27.07	32.33	34.02	47.00 -12.98 QP



Unless otherwise agreed in writing, this document is issued by the Company subject to its General Conditions of Service printed overleaf, available on request or accessible at <https://www.sgs.com/en/Terms-and-Conditions>. Attention is drawn to the limitation of liability, indemnification and jurisdiction issues defined therein. Any holder of this document is advised that information contained hereon reflects the Company's findings at the time of its intervention only and within the limits of Client's instructions, if any. The Company's sole responsibility is to its Client and this document does not exonerate parties to a transaction from exercising all their rights and obligations under the transaction documents. This document cannot be reproduced except in full, without prior written approval of the Company. Any unauthorized alteration, forgery or falsification of the content or appearance of this document is unlawful and offenders may be prosecuted to the fullest extent of the law. Unless otherwise stated the results shown in this test report refer only to the sample(s) tested and such sample(s) are retained for 30 days only.

Attention: To check the authenticity of testing /inspection report & certificate, please contact us at telephone: (86-755) 8307 1443, or email: CN.Doccheck@sgs.com
 No.1 Workshop, M-10, Middle Section, Science & Technology Park, Nanshan District, Shenzhen, Guangdong, China 518057 t (86-755) 26012053 f (86-755) 26710594 www.sgs.com.cn
 中国·广东·深圳市南山区科技园中区M-10栋1号厂房 邮编: 518057 t (86-755) 26012053 f (86-755) 26710594 sgs.china@sgs.com

6.3 Radiated Emissions (Above 1GHz)

Test Requirement: EN 55032: 2015+A11:2020+A1:2020

Test Method: EN 55032: 2015+A11:2020+A1:2020

Measurement Distance: 3m

Limit:

Frequency range(GHz)	Radiated emissions limit(dBμV/m)	
	Peak	Average
1GHz-6GHz	74	54
Detector: Peak for pre-scan (1000kHz resolution bandwidth) 1000MHz to 6000MHz		
Highest internal frequency (Fx):	Highest measured frequency:	
Fx ≤ 108MHz	1GHz	
108MHz < Fx ≤ 500MHz	2GHz	
500MHz < Fx ≤ 1GHz	5GHz	
Fx > 1GHz	5 × Fx up to a maximum of 6GHz	

6.3.1 E.U.T. Operation

Operating Environment:

Temperature: 22.8 °C

Humidity: 61.4 % RH

Atmospheric Pressure: 1005 mbar

6.3.2 Test Mode Description

Pre-scan / Final test	Mode Code	Description
Final test	00	On mode, keep EUT working normally with test board.

6.3.3 Test Setup Diagram

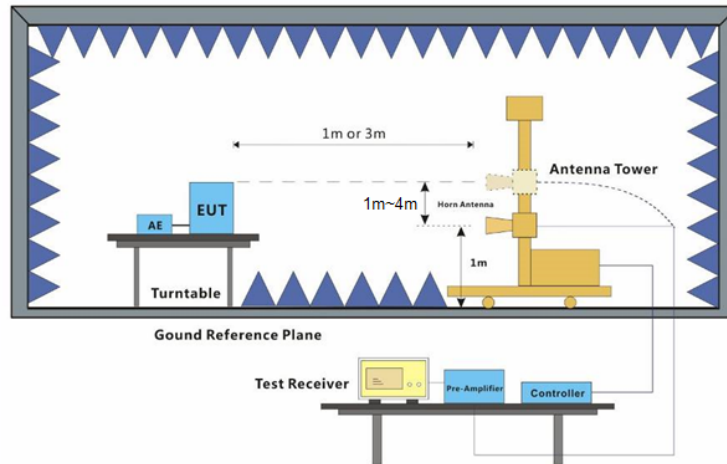

Unless otherwise agreed in writing, this document is issued by the Company subject to its General Conditions of Service printed overleaf, available on request or accessible at <https://www.sgs.com/en/Terms-and-Conditions>. Attention is drawn to the limitation of liability, indemnification and jurisdiction issues defined therein. Any holder of this document is advised that information contained hereon reflects the Company's findings at the time of its intervention only and within the limits of Client's instructions, if any. The Company's sole responsibility is to its Client and this document does not exonerate parties to a transaction from exercising all their rights and obligations under the transaction documents. This document cannot be reproduced except in full, without prior written approval of the Company. Any unauthorized alteration, forgery or falsification of the content or appearance of this document is unlawful and offenders may be prosecuted to the fullest extent of the law. Unless otherwise stated the results shown in this test report refer only to the sample(s) tested and such sample(s) are retained for 30 days only.

6.3.4 Measurement Procedure and Data

Frequency range: Above 1GHz

An initial pre-scan was performed in the chamber using the spectrum analyser in peak detection mode. Average measurements were conducted based on the peak sweep graph. The EUT was measured by Horn antenna with 2 orthogonal polarities.

The red line show in graphic is the limit in standard used in this section.

Level=Read Level + Antenna Factor + Cable Loss - Preamp Factor



Test Mode: 00; Polarity: Horizontal

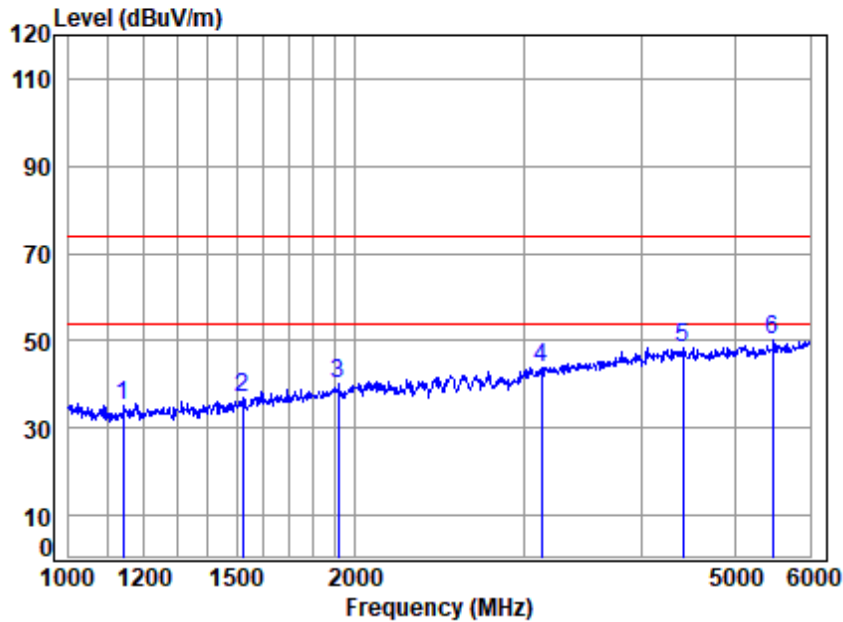

Site : chamber
 Condition: 3m HORIZONTAL
 Job No : 04051AT
 Mode : 00

	Freq	Cable Loss	Ant Factor	Preamp Factor	Read Level	Limit Level	Over Limit	Remark
	MHz	dB	dB/m	dB	dBuV	dBuV/m	dBuV/m	dB
1	1141.782	2.70	24.17	37.90	46.34	35.31	74.00	-38.69 Peak
2	1523.581	3.27	25.64	36.81	44.70	36.80	74.00	-37.20 Peak
3	1919.760	3.73	27.52	35.94	45.05	40.36	74.00	-33.64 Peak
4	3136.610	5.04	31.40	35.28	42.77	43.93	74.00	-30.07 Peak
5	4408.687	6.69	33.50	34.61	42.70	48.28	74.00	-25.72 Peak
6 q	5485.847	7.69	34.60	35.01	42.78	50.06	74.00	-23.94 Peak



Test Mode: 00; Polarity: Vertical

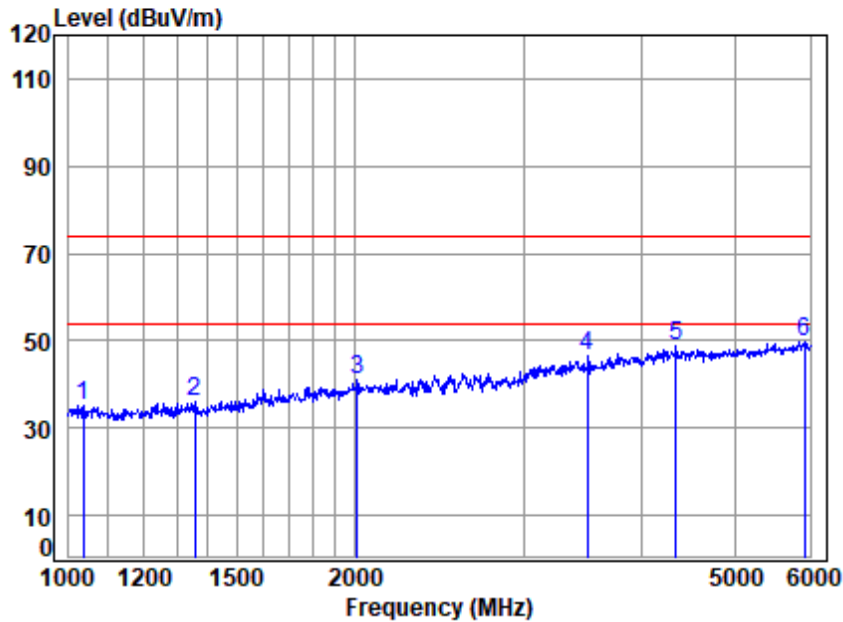

Site : chamber
 Condition: 3m VERTICAL
 Job No : 04051AT
 Mode : 00

	Freq	Cable Loss	Ant Factor	Preamp Factor	Read Level	Limit Level	Over Line	Over Limit	Remark
	MHz	dB	dB/m	dB	dBuV	dBuV/m	dBuV/m	dB	
1	1034.630	2.51	24.58	38.27	46.35	35.17	74.00	-38.83	Peak
2	1356.081	3.04	24.91	37.25	45.18	35.88	74.00	-38.12	Peak
3	2007.709	3.82	28.15	35.79	44.83	41.01	74.00	-32.99	Peak
4	3505.144	5.61	31.80	34.84	43.97	46.54	74.00	-27.46	Peak
5	4338.163	6.62	33.60	34.57	43.02	48.67	74.00	-25.33	Peak
6 q	5914.609	8.09	34.83	35.04	42.07	49.95	74.00	-24.05	Peak



6.4 Voltage Fluctuations and Flicker

Test Requirement: EN 61000-3-3: 2013+ A1:2019+A2:2021

Test Method: EN 61000-3-3: 2013+ A1:2019+A2:2021

6.4.1 E.U.T. Operation

Operating Environment:

Temperature: 21.6 °C Humidity: 59.4 % RH Atmospheric Pressure: 1005 mbar

6.4.2 Test Mode Description

Pre-scan / Final test	Mode Code	Description
Final test	00	On mode, keep EUT working normally with test board.

6.4.3 Test Setup Diagram

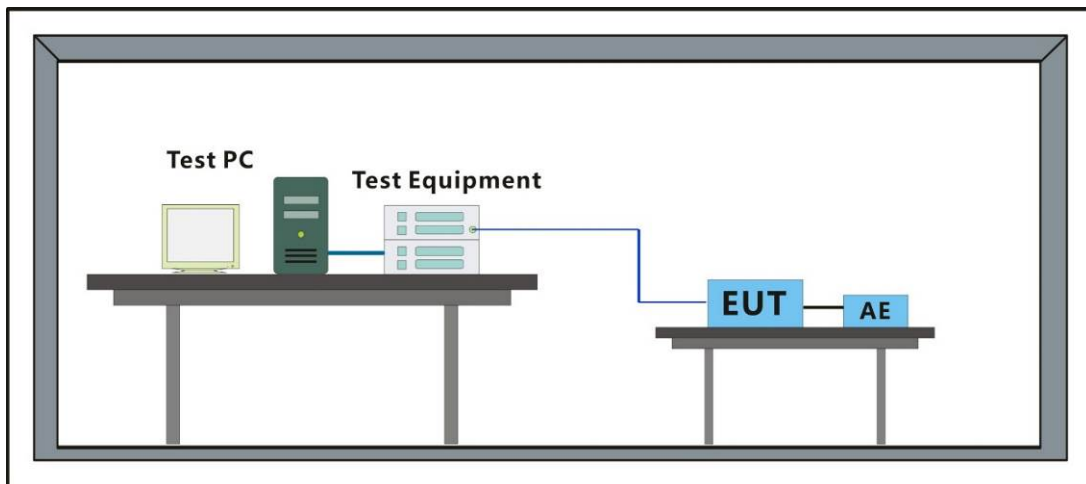

6.4.4 Measurement Procedure and Data



Unless otherwise agreed in writing, this document is issued by the Company subject to its General Conditions of Service printed overleaf, available on request or accessible at <https://www.sgs.com/en/Terms-and-Conditions>. Attention is drawn to the limitation of liability, indemnification and jurisdiction issues defined therein. Any holder of this document is advised that information contained hereon reflects the Company's findings at the time of its intervention only and within the limits of Client's instructions, if any. The Company's sole responsibility is to its Client and this document does not exonerate parties to a transaction from exercising all their rights and obligations under the transaction documents. This document cannot be reproduced except in full, without prior written approval of the Company. Any unauthorized alteration, forgery or falsification of the content or appearance of this document is unlawful and offenders may be prosecuted to the fullest extent of the law. Unless otherwise stated the results shown in this test report refer only to the sample(s) tested and such sample(s) are retained for 30 days only.

Test Result: Pass

Status: Test Completed

Pst and limit line

European Limits



Plt and limit line

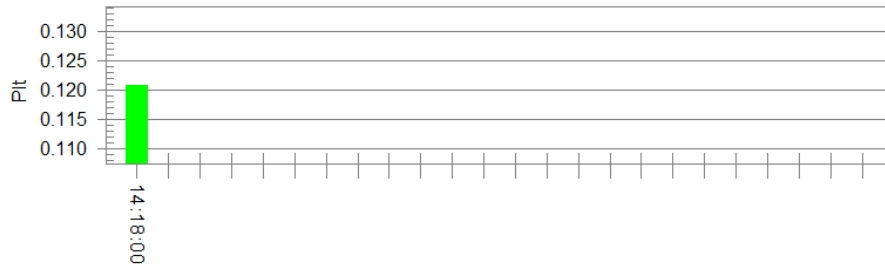

Parameter values recorded during the test:

Vrms at the end of test (Volt):	229.98		
Highest dt (%):		Test limit (%):	
T-max (mS):	0	Test limit (mS):	500.0 Pass
Highest dc (%):	0.00	Test limit (%):	3.30 Pass
Highest dmax (%):	0.00	Test limit (%):	4.00 Pass
Highest Pst (10 min. period):	0.277	Test limit:	1.000 Pass



6.5 Harmonic Current Emission

Test Requirement: EN IEC 61000-3-2: 2019+A1:2021

Test Method: EN IEC 61000-3-2: 2019+A1:2021

6.5.1 Conclusion

There is no need for Harmonics test to be performed on this product (rated power is less than 75W) in accordance with EN IEC 61000-3-2: 2019+A1:2021.

For further details, please refer to Clause 7 of EN IEC 61000-3-2: 2019+A1:2021 which states:

"For the following categories of equipment, limits are not specified in this standard.

equipment with a rated power of 75W or less, other than lighting equipment."



7 Immunity Test Results

General Performance Criteria Description in EN 55035: 2017+A11:2020

- Criterion A** The equipment shall continue to operate as intended without operator intervention. No degradation of performance, loss of function or change of operating state is allowed below a performance level specified by the manufacturer when the equipment is used as intended. The performance level may be replaced by a permissible loss of performance. If the minimum performance level or the permissible performance loss is not specified by the manufacturer, then either of these may be derived from the product description and documentation, and by what the user may reasonably expect from the equipment if used as intended.
- Criterion B** During the application of the disturbance, degradation of performance is allowed. However, no unintended change of actual operating state or stored data is allowed to persist after the test. After the test, the equipment shall continue to operate as intended without operator intervention; no degradation of performance or loss of function is allowed, below a performance level specified by the manufacturer, when the equipment is used as intended. The performance level may be replaced by a permissible loss of performance. If the minimum performance level (or the permissible performance loss), or recovery time, is not specified by the manufacturer, then either of these may be derived from the product description and documentation, and by what the user may reasonably expect from the equipment if used as intended.
- Criterion C** Loss of function is allowed, provided the function is self-recoverable, or can be restored by the operation of the controls by the user in accordance with the manufacturer's instructions. A reboot or re-start operation is allowed. Information stored in non-volatile memory, or protected by a battery backup, shall not be lost.



Performance Criteria Description for Broadcast reception function

The broadcast reception function shall comply with the general performance criteria given in Clause 8 and any relevant annex with the deviations defined in Table A.2.

NOTE For the continuous RF electromagnetic field immunity test specified in the table clauses 1.2 and 1.3, deviations apply for in-band frequencies. The deviations depend on the class of the broadcast receiver (Group 1 or 2) and are defined in Table A.2.

Table A.2 – Modified test levels for performance criterion A for the broadcast reception function

Performance criteria	Test type table clause	Group 1	Group 2
A	1.2	The disturbance level is reduced to 1 V/m for in-band frequencies.	No test requirements apply
	1.3		
	2.1	The disturbance level is reduced to 1 V for in-band frequencies.	
	3.1		
4.1			

In-band is defined as the entire tuneable operating range of the selected broadcast reception function. The tuned channel $\pm 0,5$ MHz (lower edge frequency – 0,5 MHz up to the upper edge frequency + 0,5 MHz of the tuned channel) is excluded from testing.
NOTE In some countries, there is a requirement to test the tuned channels. Refer to the relevant regional requirements for guidance.



Performance Criteria Description for Print function

- Criterion A Apply criterion A as defined in 8.2. Additionally, the following shall not occur as a consequence of the application of the disturbance:
- change of operating state;
 - unintended pausing of the print operation;
 - a change of print quality or legibility, as appropriate to the test pattern;
 - change of character font;
 - unintended line feed;
 - unintended page feed;
 - paper feed failure.
- Criterion B Apply criterion B as defined in 8.3 with the following specifics and additional limitations. Paper feed failures are allowed only if, after removal of the jammed sheets, the job is automatically recovered and there is no loss of printed information. Any low-quality print output caused by the application of the disturbance shall not continue beyond the sheet of media being printed, or beyond the typical length of a finished page or sheet printed from continuous roll media. False indicators are permitted during the test provided that a normal operator response to that false indicator is simple (such as pressing a button). False indicators are not acceptable if they would cause the user to discard printing supplies such as ink, toner or paper, when those supplies are actually not empty or faulty. Any false indicator shall either clear automatically or after the operator's response. After the disturbance, the print function may print the remainder of the print job at a quality level within the manufacturer's specifications. Alternately, the print function may halt processing of a print job as a result of the disturbance, but only if the operator is capable of reprinting the job (for example, a fax printing job where the image to be printed still resides in local memory). Automatically restarting the print job from the beginning is also acceptable. In any scenario, the pairing of front and back images during double-sided printing shall be correct.
- Criterion C Loss of function is allowed, provided the function is self-recoverable, or can be restored by the operation of the controls by the user in accordance with the manufacturer's instructions. A reboot or re-start operation is allowed. Information stored in non-volatile memory, or protected by a battery backup, shall not be lost.



Performance Criteria Description for Scan function

- Criterion A Apply criterion A as defined in 8.2. Additionally, the following shall not occur as a consequence of the application of the test:
 - change of settings, such as which side(s) of the page to be scanned, colour or monochrome, and resolution;
 - corruption of the image, for example stretching, compressing or change in colour;
 - paper feed failures;
 - errors in the reading of bar codes.
- Criterion B Apply criterion B as defined in 8.3 with the following specifics and additional limitations:
 - Document feed failures are allowed only if the original documents are undamaged and, after removal of the jammed sheets, the job is automatically recovered and there is no loss of scanned information.
 - During the test, the representation of the image shall not be degraded such that reading mistakes occur.
- Criterion C Loss of function is allowed, provided the function is self-recoverable, or can be restored by the operation of the controls by the user in accordance with the manufacturer’s instructions. A reboot or re-start operation is allowed.
Information stored in non-volatile memory, or protected by a battery backup, shall not be lost.

Performance Criteria Description for Display and display output functions

Performance criterion A for continuous radiated and conducted disturbances tests

Apply criterion A as defined in 8.2. Additionally, an increase in any degradation greater than just perceptible by observation of the image shall not occur as a consequence of the application of the test. Examples of such degradations are:

- superimposed patterning;
- positional disturbances due to synchronisation errors;
- geometric distortion;
- change of contrast or brightness;
- picture artefacts;
- freezing or disturbance of motion;
- image loss;
- video data or decoding errors.

Performance criterion A for the power frequency magnetic field tests

Alternative 1: A continuous magnetic field of 1 A/m:

The jitter (in mm) shall not exceed the value
$$\frac{(\text{character height in mm} + 0,3) \times 2,5}{33,3}$$



Alternative 2: An increased power frequency magnetic field ≤ 50 A/m:

The amplitude of the disturbing field shall be increased by a factor K , where $1 \leq K \leq 50$. The jitter shall not exceed K times the value given in alternative 1. The value of K should be chosen to avoid saturation of any magnetic screening materials.

When the EUT is subjected to fields above $K = 1$ and the performance criteria are satisfied for all relevant functions of the EUT, the EUT shall be deemed to satisfy the requirement. When the EUT is subjected to fields above $K = 1$ and the display function is shown to meet these performance criteria, but the performance criteria for other relevant functions are NOT satisfied, the EUT shall be retested at $K = 1$ (the field level required in table clause 1.1) to assess compliance for those other functions.

Performance criterion B

During the application of the disturbance, degradation of performance is allowed. However, no unintended change of actual operating state or stored data is allowed to persist after the test.

After the test, the equipment shall continue to operate as intended without operator intervention; no degradation of performance or loss of function is allowed, below a performance level specified by the manufacturer, when the equipment is used as intended.

The performance level may be replaced by a permissible loss of performance.

If the minimum performance level (or the permissible performance loss), or recovery time, is not specified by the manufacturer, then either of these may be derived from the product description and documentation, and by what the user may reasonably expect from the equipment if used as intended.

Performance criterion C

Loss of function is allowed, provided the function is self-recoverable, or can be restored by the operation of the controls by the user in accordance with the manufacturer's instructions. A reboot or re-start operation is allowed.

Information stored in non-volatile memory, or protected by a battery backup, shall not be lost.



Unless otherwise agreed in writing, this document is issued by the Company subject to its General Conditions of Service printed overleaf, available on request or accessible at <https://www.sgs.com/en/Terms-and-Conditions>. Attention is drawn to the limitation of liability, indemnification and jurisdiction issues defined therein. Any holder of this document is advised that information contained hereon reflects the Company's findings at the time of its intervention only and within the limits of Client's instructions, if any. The Company's sole responsibility is to its Client and this document does not exonerate parties to a transaction from exercising all their rights and obligations under the transaction documents. This document cannot be reproduced except in full, without prior written approval of the Company. Any unauthorized alteration, forgery or falsification of the content or appearance of this document is unlawful and offenders may be prosecuted to the fullest extent of the law. Unless otherwise stated the results shown in this test report refer only to the sample(s) tested and such sample(s) are retained for 30 days only.

Attention: To check the authenticity of testing /inspection report & certificate, please contact us at telephone: (86-755) 8307 1443, or email: CN.Doccheck@sgs.com

Performance Criteria Description for Musical tone generating function

General

The particular performance criteria for evaluating the musical tone generating function are defined in E.3.2, E.3.3 and E.3.4.

Performance criterion A

Performance criterion A is subdivided according to the type of equipment and its use. Three subgroups corresponding to different equipment types are defined in Table E.1 and have corresponding performance criteria A1, A2 and A3. The relevant subgroup shall be selected by the manufacturer in accordance with the product specification. The description of criteria A1, A2 and A3 are presented in Table E.2.

Table E.1 – Subgroups and performance criteria A for the musical tone generating function

Equipment type and use	Subgroup	Performance Criteria
High-end quality suitable for professional use or studio recording	1	A1
Middle grade quality suitable for amateur use or home use	2	A2
Entry grade quality for practice or exercise use	3	A3

Table E.2 – Performance criteria for different subgroups given in Table E.1

Description of degradation in performance	Performance Criteria		
	A1	A2	A3
Specific unintended change in the characteristic of the tone generated 1. interruption 2. stopping (or ceasing) 3. holding 4. sudden change in amplification	Not acceptable	Not acceptable	Not acceptable
Specific unintended change in the characteristic of the tone generated 1. frequency 2. harmonic distortion	Not acceptable	Not acceptable if the degradation is beyond the level specified by the manufacturer	Not acceptable if the manufacturer judges such degradations interfere with the continuation of playing music
Other changes in the type of tone generated	Not acceptable	Not acceptable	Not acceptable if the manufacturer judges such degradations interfere with the continuation of playing music

The specified degradations shall be perceptible to a listener.
During the test no performance degradation other than that permitted by this table is allowed. After the test the EUT shall operate without performance degradation.



Performance criterion B

During the test, degradation of performance beyond that defined in criterion A1 of Table E.2 is allowed. However, sudden amplification of tone to a level that exceeds the expected level by more than 6 dB is not allowed.

After the test, normal operation of the EUT shall be self-recovered.

In the case of unintended tone holding caused by a MIDI protocol communication error, the EUT can be re-initialised by the operation of the controls by the user controls in accordance with the manufacturer's instructions.

Due to the nature of the MIDI protocol, it is necessary to modify the performance criterion B to allow user intervention when the unintended tone holding is caused by a missing MIDI communication error (for example missing a 'NOTE OFF' message).

Performance criterion C

Degradation of the performance beyond that defined in criterion A1 of Table E.2 is permitted provided that the normal operation of the EUT can be restored after the test by operator intervention. However, sudden amplification of tone to a level that exceeds the expected level by more than 6 dB is not allowed.



Performance Criteria Description for Networking functions

General Requirements for Network functions

Performance criterion A

Where relevant, during the application of the test the network function shall, as a minimum, operate ensuring that:

- established connections shall be maintained throughout the application of the test;
- no change of operational state or corruption of stored data occurs;
- no increase in error rate above the figure defined by the manufacturer occurs. The manufacturer should select the most appropriate performance measurement criteria for the product or system, for example bit error rate, block error rate;
- no request for retry above the figure defined by the manufacturer;
- the data transmission rate does not reduce below the figure defined by the manufacturer;
- no protocol failure occurs;
- the audio noise level at a two-wire analogue interface (supporting telephony) shall satisfy the requirements of Table G.3. The audio level measurements shall be performed at the demodulated frequency of the disturbance using a narrowband filter with a 3dB bandwidth of 100 Hz using the method defined in table clause G.1.4. See G.6.1.

As described in the example given in J.3.5 the networking function is monitored during testing using direct functions specified elsewhere in this document.

If needed to verify the operation of the protocol, the following functions shall be verified as described in Table H.1 when performing the additional spot frequency tests contained in Clause 5:

- ability to establish a connection,
- ability to clear a connection.

Where an EUT has supervisory functions they shall not be affected. Elements that should be monitored include, but are not limited to:

- alarms,
- signalling lamps,
- printer output errors,
- network traffic rates,
- network monitor errors,
- measured network parameters.

Performance criterion B

Established connections shall be maintained throughout the test, or shall self-recover in a way and timescale that is imperceptible to the user.

The error rate, request for retry and data transmission rates may be degraded during the application of the test. Degradation of the performance as described in criterion A is permitted, provided that the normal operation of the EUT is self-recoverable to the condition established prior to the application of the test.

Where required, as defined in Clause 5, the acceptable operation of the function shall be verified at the completion of the test as described in Table H.1, by confirming the following:

- the EUT's ability to establish a connection,
- the EUT's ability to clear a connection.

During surge testing disconnection is allowed on the analogue/digital data port being tested.

If the EUT is a supervisory equipment, it shall not impact the normal operation of the network being monitored. In addition, any supervisory functions impacted during the period of the test shall return to the state prior to the test. Elements to consider include:

- alarms,
- signalling lamps,
- printer output,
- network traffic rates,
- network monitoring.



Unless otherwise agreed in writing, this document is issued by the Company subject to its General Conditions of Service printed overleaf, available on request or accessible at <https://www.sgs.com/en/Terms-and-Conditions>. Attention is drawn to the limitation of liability, indemnification and jurisdiction issues defined therein. Any holder of this document is advised that information contained hereon reflects the Company's findings at the time of its intervention only and within the limits of Client's instructions, if any. The Company's sole responsibility is to its Client and this document does not exonerate parties to a transaction from exercising all their rights and obligations under the transaction documents. This document cannot be reproduced except in full, without prior written approval of the Company. Any unauthorized alteration, forgery or falsification of the content or appearance of this document is unlawful and offenders may be prosecuted to the fullest extent of the law. Unless otherwise stated the results shown in this test report refer only to the sample(s) tested and such sample(s) are retained for 30 days only.

Attention: To check the authenticity of testing /inspection report & certificate, please contact us at telephone: (86-755) 8307 1443, or email: CN.Doccheck@sgs.com

Performance criterion C

Degradation of performance as described in criteria A and B is permitted provided that the normal operation of the EUT is self-recoverable to the condition immediately before the application of the test, or can be restored after the test by the operator.

Requirements for CPE containing xDSL ports

Performance criterion A

Applicable for the test requirement defined in table clause 2.1

During the swept frequency test, the established connection shall be maintained throughout the testing and the information transferred without any additional reproducible errors or loss of synchronisation. If degradation in performance is observed and the system is adaptive, for example has the capability to automatically retrain in the presence of an interfering signal, then perform the following procedure:

- a) For each range of interfering frequencies in which degradation in performance is observed, three frequencies (beginning, middle and end) shall be identified.
- b) At each of the frequencies identified in step a), the interfering signal shall be applied and the system shall be allowed to retrain.
- c) If the system is able to retrain and then functions correctly for a dwell time of at least 60 s without any additional reproducible errors or loss of synchronisation, then the performance level of the system is considered acceptable.
- d) The frequencies identified in step a) and the data rates achieved in step b) shall be recorded in the test report.

Applicable for the test requirement defined in table clause 2.2

It is important that the modems are able to train in the presence of repetitive impulsive noise and minimize disruption to the end-user where a repetitive impulsive noise source starts after the link has synchronized. Therefore the following procedure and performance criteria shall apply.

The manufacturer shall select the class of impulsive noise protection (INP) to be used for the immunity test and should state this information in the technical documentation and in the test report. The maximum delay shall be set to 8 ms.

In the absence of impulsive noise: The modem shall operate without retraining at its target noise margin with a bit rate value depending on the line attenuation and the stationary noise being present on the line. (The actual value will be between the minimum and maximum bit rate values programmed in the port). The impulsive noise source shall then be applied at the required test level.

With the impulsive noise applied: The modem shall operate without retraining and without SES at the bit rate established prior to the application of the impulsive noise. No extra CRC errors shall occur due to the impulsive noise.

Applicable for the test requirements defined in other subclauses

The equipment shall continue to operate as intended without operator intervention. No degradation of performance, loss of function or change of operating state is allowed below a performance level specified by the manufacturer when the equipment is used as intended.

The performance level may be replaced by a permissible loss of performance. If the minimum performance level or the permissible performance loss is not specified by the manufacturer, then either of these may be derived from the product description and documentation, and by what the user may reasonably expect from the equipment if used as intended.



Performance criterion B

F.4.3.1 Applicable for the test requirement defined in table clause 2.3

Modems shall withstand the application of the isolated impulsive noise events. The performance criteria defined in Table F.3 shall be applied.

Table F.3 – Performance criteria against impulse duration

Impulse duration ms	Performance criteria
0,24	The application of the impulse shall not cause the xDSL link to lose synchronisation. No CRC errors are permitted.
10	The application of the 5 impulses shall result in less than 75 CRC errors and shall not cause the link to lose synchronisation.
300	The application of the impulse shall not cause the xDSL link to lose synchronisation.



Unless otherwise agreed in writing, this document is issued by the Company subject to its General Conditions of Service printed overleaf, available on request or accessible at <https://www.sgs.com/en/Terms-and-Conditions>. Attention is drawn to the limitation of liability, indemnification and jurisdiction issues defined therein. Any holder of this document is advised that information contained hereon reflects the Company's findings at the time of its intervention only and within the limits of Client's instructions, if any. The Company's sole responsibility is to its Client and this document does not exonerate parties to a transaction from exercising all their rights and obligations under the transaction documents. This document cannot be reproduced except in full, without prior written approval of the Company. Any unauthorized alteration, forgery or falsification of the content or appearance of this document is unlawful and offenders may be prosecuted to the fullest extent of the law. Unless otherwise stated the results shown in this test report refer only to the sample(s) tested and such sample(s) are retained for 30 days only.

Attention: To check the authenticity of testing /inspection report & certificate, please contact us at telephone: (86-755) 8307 1443, or email: CN.Doccheck@sgs.com

Applicable for the test requirements defined in table clauses 2.5 and 4.5

For application of this test to the xDSL port, a repetition rate of 100 kHz (burst length 0,75 ms) shall be used. For the application of this test to the AC mains power port, a repetition rate of 5 kHz shall be used. Degradation of the performance as described in criterion A (defined in F.4.2.1) is permitted in that errors are acceptable during the application of the test. However the application of the test shall not cause the system to lose the established connection or re-train. At the cessation of the test, the system shall operate in the condition established prior to the application of the test without user intervention. After the application of the EFT/B tests to the xDSL or AC mains power port, as defined in table clauses 2.5 and 4.5, the CRC error count shall not have increased by more than 600 when compared to the count prior to the application of the test.

Applicable for the test requirements defined in other subclauses

During the application of the disturbance, degradation of performance is allowed. However, no unintended change of actual operating state or stored data is allowed to persist after the test. After the test, the equipment shall continue to operate as intended without operator intervention; no degradation of performance or loss of function is allowed, below a performance level specified by the manufacturer, when the equipment is used as intended. The performance level may be replaced by a permissible loss of performance. If the minimum performance level (or the permissible performance loss), or recovery time, is not specified by the manufacturer, then either of these may be derived from the product description and documentation, and by what the user may reasonably expect from the equipment if used as intended.

Performance criterion C

Degradation of the performance beyond that defined in criteria A and B is permitted provided that the normal operation of the EUT is self-recoverable to the condition established prior to application of the test or can be restored after the test by the operator.



Unless otherwise agreed in writing, this document is issued by the Company subject to its General Conditions of Service printed overleaf, available on request or accessible at <https://www.sgs.com/en/Terms-and-Conditions>. Attention is drawn to the limitation of liability, indemnification and jurisdiction issues defined therein. Any holder of this document is advised that information contained hereon reflects the Company's findings at the time of its intervention only and within the limits of Client's instructions, if any. The Company's sole responsibility is to its Client and this document does not exonerate parties to a transaction from exercising all their rights and obligations under the transaction documents. This document cannot be reproduced except in full, without prior written approval of the Company. Any unauthorized alteration, forgery or falsification of the content or appearance of this document is unlawful and offenders may be prosecuted to the fullest extent of the law. Unless otherwise stated the results shown in this test report refer only to the sample(s) tested and such sample(s) are retained for 30 days only.

Attention: To check the authenticity of testing /inspection report & certificate, please contact us at telephone: (86-755) 8307 1443, or email: CN.Doccheck@sgs.com

Performance Criteria Description for Audio output function

Performance criterion A

General

During the test the audio output function shall be maintained and the requirements of G.7.1.2 or G.7.1.3 shall be met.

Devices supporting telephony functions

For devices that support telephony functions the limits of Table G.3 shall apply. With respect to Table G.3,

- the interference ratio (electrical or acoustic) shall meet the limits in column 3; or,
- the acoustic level of the demodulated audio shall be less than the limits in column 4; or,
- the digitally coded level of demodulated audio shall be less than limits in column 5; or,
- the analogue level of the demodulated audio shall be less than the limits in column 6.

Table G.3 – Performance criterion A – Limits for devices supporting telephony

Type of immunity test	Frequency range MHz	Acoustic or electrical interference ratio	Equivalent direct measurement		
			dB(SPL)	Digital dBm0	Analogue dBm
Conducted ^a	0,15 to 30	-20 dB	55	-50	-50
	30 to 80	-10 dB	65	-40	-40
Radiated	80 to 1 000	0 dB	75	-30	-30

^a At the step in the frequency range, the lower limit shall be applied.

The equivalent direct measurement values are presented to show the equivalency of the interference ratio in comparison to a direct measured value. These values may be used if the direct measurement method of the test is used.

The values within this table are aligned with CISPR 24, noting that the test levels are different between this document and CISPR 24.

For terminals connected to digital wired network ports (such as Ethernet, ISDN), measurements of the demodulated 1 kHz may be performed on a remote AE, ideally of the same design.

NOTE The amplitude demodulation disturbances will arise, almost invariably, from semi-conductor junctions behaving as inadvertent square law detectors. This means that for a 10 dB increase in the applied test level, for example, from 1 V to 3 V, the demodulated line noise will increase by 20 dB. This 20dB offset was used to derive the values in Table G.3.

For all other devices

The measured acoustic interference ratio and/or the measured electrical interference ratio during the test shall be -20 dB or better.



Unless otherwise agreed in writing, this document is issued by the Company subject to its General Conditions of Service printed overleaf, available on request or accessible at <https://www.sgs.com/en/Terms-and-Conditions>. Attention is drawn to the limitation of liability, indemnification and jurisdiction issues defined therein. Any holder of this document is advised that information contained hereon reflects the Company's findings at the time of its intervention only and within the limits of Client's instructions, if any. The Company's sole responsibility is to its Client and this document does not exonerate parties to a transaction from exercising all their rights and obligations under the transaction documents. This document cannot be reproduced except in full, without prior written approval of the Company. Any unauthorized alteration, forgery or falsification of the content or appearance of this document is unlawful and offenders may be prosecuted to the fullest extent of the law. Unless otherwise stated the results shown in this test report refer only to the sample(s) tested and such sample(s) are retained for 30 days only.

Attention: To check the authenticity of testing /inspection report & certificate, please contact us at telephone: (86-755) 8307 1443, or email: CN.Doccheck@sgs.com

Performance criterion B

During the application of the disturbance, degradation of performance is allowed. However, no unintended change of actual operating state or stored data is allowed to persist after the test.

After the test, the equipment shall continue to operate as intended without operator intervention; no degradation of performance or loss of function is allowed, below a performance level specified by the manufacturer, when the equipment is used as intended.

The performance level may be replaced by a permissible loss of performance.

If the minimum performance level (or the permissible performance loss), or recovery time, is not specified by the manufacturer, then either of these may be derived from the product description and documentation, and by what the user may reasonably expect from the equipment if used as intended.

Performance criterion C

Loss of function is allowed, provided the function is self-recoverable, or can be restored by the operation of the controls by the user in accordance with the manufacturer's instructions. A reboot or re-start operation is allowed.

Information stored in non-volatile memory, or protected by a battery backup, shall not be lost.

Test setup examples

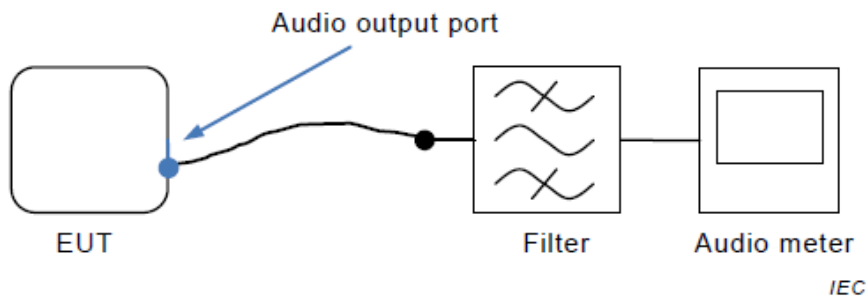

The filter is the audio filter specified in G.6.1 and is typically incorporated into the audio meter. Additional filtering might be necessary to ensure that the RF disturbance signal does not interfere with the measurement.

Figure G.1 – Example basic test setup for electrical measurements

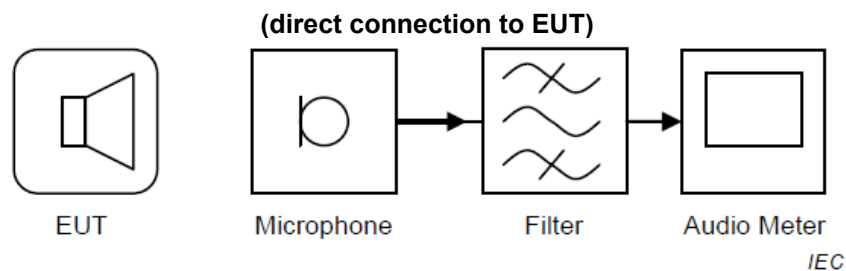

The filter is the audio filter specified in G.6.1 and is typically incorporated into the audio meter. Additional filtering might be necessary to ensure that the RF disturbance signal does not interfere with the measurement.

Figure G.2 – Example basic test setup for acoustic measurements



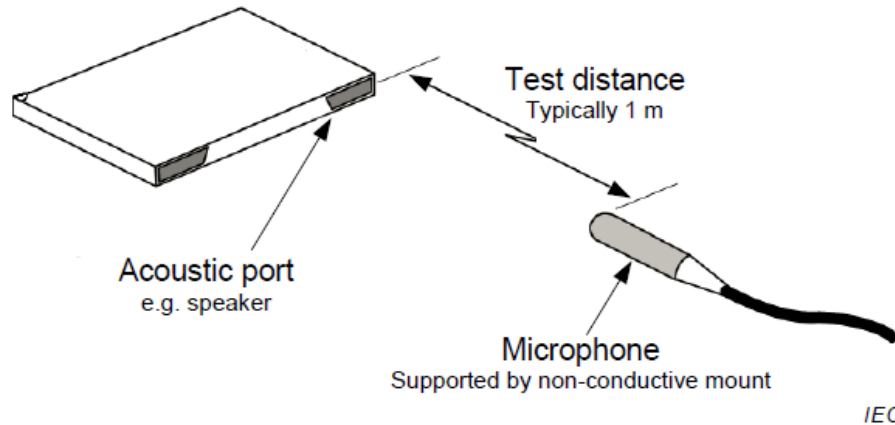

The microphone is connected via the cable to a suitable amplifier. Ensure that there is minimal acoustic loss between EUT and microphone.

Figure G.3 – Example test setup for acoustic measurements on loudspeakers

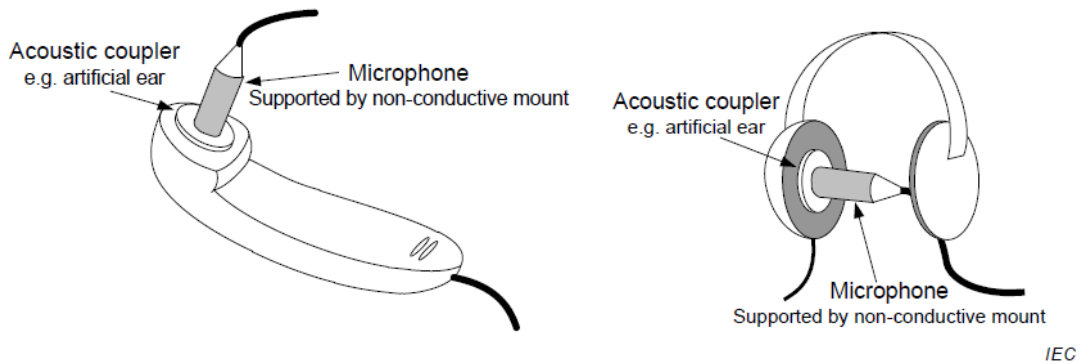

NOTE 1 The microphone is connected via the cable to a suitable amplifier.

NOTE 2 This setup cannot be suitable for radiated testing. See G.6.3.

Figure G.4 – Example test setup for on-ear acoustic measurements



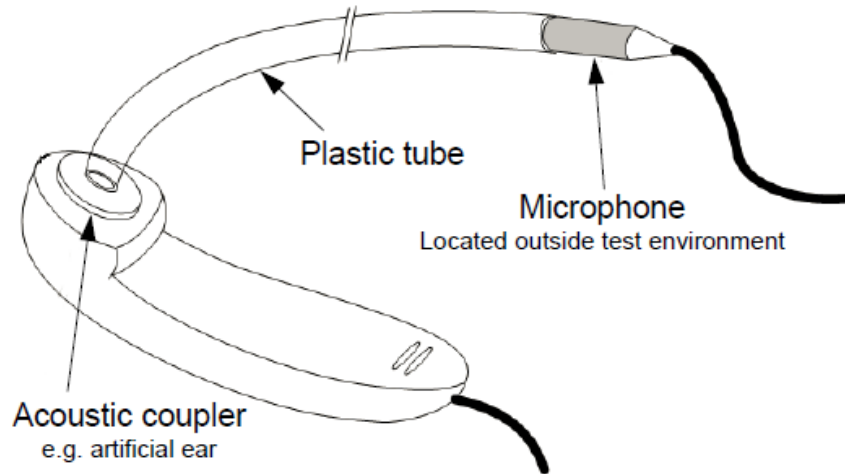

IEC

NOTE 1 The microphone is connected via the cable to a suitable amplifier.

NOTE 2 This setup is suitable for radiated immunity testing. See G.6.3

Figure G.5 – Example test setup for on-ear acoustic measurements, microphone located away from earpiece transducer

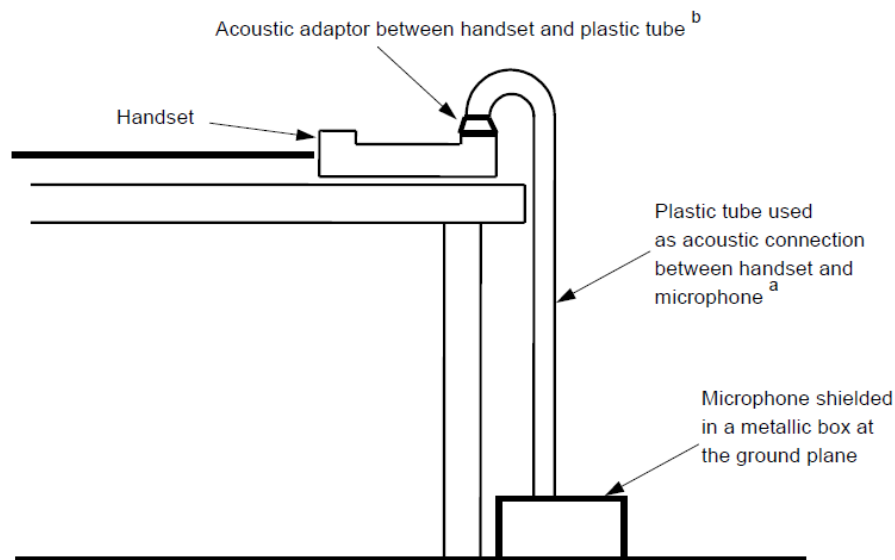

IEC

NOTE This set up is suitable for radiated immunity testing. See G.6.3.

^a The acoustic measurement procedure compensates for the acoustic properties of the tube. Typically, the tube has an inner diameter of 15 mm, an outer diameter of 19 mm, and a total length of 1,5 m.

^b Conically formed adaptor which is connected acoustically to the various forms of handsets with some type of soft rubber. This stable coupling of the handset to the acoustical tube should not be changed between establishing the reference level and measuring the demodulated levels.

Figure G.6 – Example test setup for measuring the sound pressure level from the acoustic output device of a telephone handset



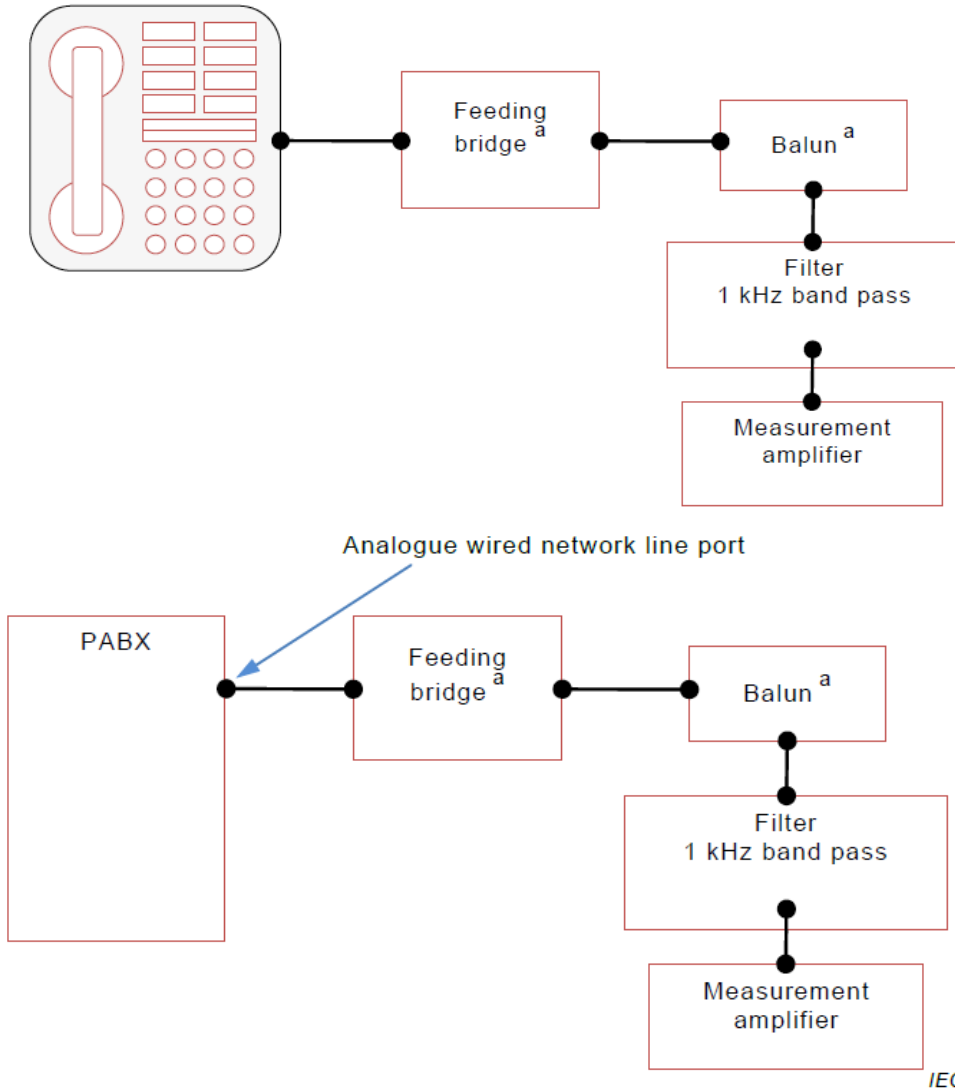

^a The feeding bridge current and the balun impedance are to be chosen according to the intended purpose of the EUT. In addition the feeding bridge may provide the power required for the MME to operate.

Figure G.7 – Example test setups for measuring the demodulation on analogue wired network lines



Performance Criteria Description for Telephony function

Table H.1 defines the performance criteria for various telephony functions that shall be exercised (or operated) in the presence of the disturbances specified in Table 1 to Table 4.

Table H.1 – Telephony functions, performance criteria

Function to be exercised	Performance criteria		
	A	B	C
Establish new communication	At the additional spot frequency tests ^{a, c}	Performed before and after the application of the test or disturbance	Performed before and after the application of the test or disturbance
Maintain established communication	Yes In addition, the requirements of Annex G for the audio output function shall be satisfied ^c	Yes ^b	No
Terminate established communication	At the additional spot frequency tests ^{a, c}	Performed before and after the application of the test or disturbance	Performed before and after the application of the test or disturbance

Communication refers to a telephone call or other form of voice connection.

^a Applicable to TTE with a dial function that provides dedicated emergency service/safety of life call capability. Where the EUT does not provide this functionality, this limitation shall be stated in the equipment user manual.

^b Communication shall be established prior to the application of the disturbance, the communication shall be maintained and the quality of that communication (for example, volume setting, the level of background noise) shall be maintained after completion of the test or disturbance.

^c Where defined in Clause 5 (for the tests in Table 1 to Table 4), these functional tests shall be performed during the additional spot frequency tests.



Unless otherwise agreed in writing, this document is issued by the Company subject to its General Conditions of Service printed overleaf, available on request or accessible at <https://www.sgs.com/en/Terms-and-Conditions>. Attention is drawn to the limitation of liability, indemnification and jurisdiction issues defined therein. Any holder of this document is advised that information contained hereon reflects the Company's findings at the time of its intervention only and within the limits of Client's instructions, if any. The Company's sole responsibility is to its Client and this document does not exonerate parties to a transaction from exercising all their rights and obligations under the transaction documents. This document cannot be reproduced except in full, without prior written approval of the Company. Any unauthorized alteration, forgery or falsification of the content or appearance of this document is unlawful and offenders may be prosecuted to the fullest extent of the law. Unless otherwise stated the results shown in this test report refer only to the sample(s) tested and such sample(s) are retained for 30 days only.

Attention: To check the authenticity of testing /inspection report & certificate, please contact us at telephone: (86-755) 8307 1443, or email: CN.Doccheck@sgs.com

7.1 Electrostatic Discharge

Test Requirement: EN 55035: 2017+A11:2020

Test Method: EN 61000-4-2: 2009

7.1.1 Test Setup Diagram

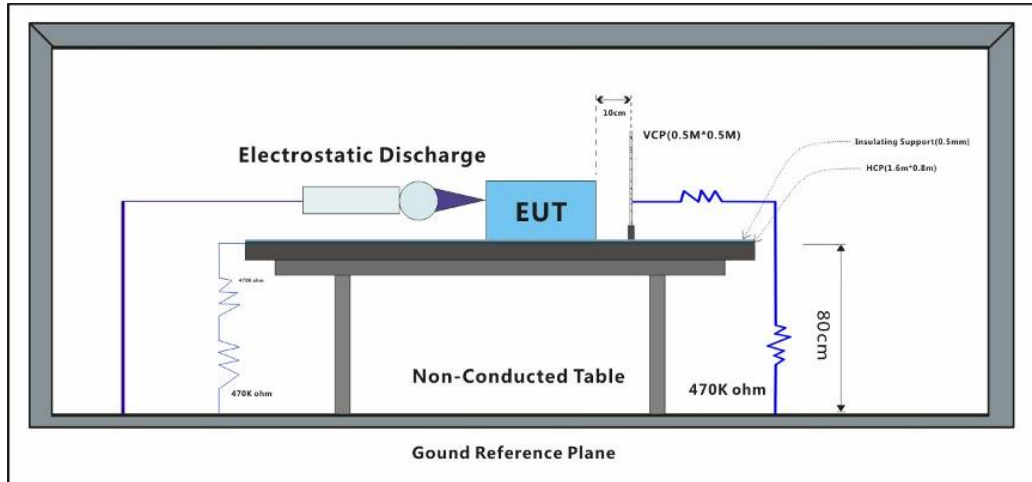

7.1.2 E.U.T. Operation

Operating Environment:

Temperature: 23.5 °C

Humidity: 46.6 % RH

Atmospheric Pressure: 1005 mbar

7.1.3 Test Mode Description

Pre-scan / Final test	Mode Code	Description
Final test	00	On mode, keep EUT working normally with test board.

7.1.4 Test Condition and Results:

Performance Criterion: B

Discharge Impedance: 330Ω/150pF

Number of Discharge: Minimum 10 times at each test point

Discharge Mode: Single Discharge

Discharge Period: 1 second minimum

Test Point 1: All insulated enclosure & seams.

Test Point 2: All accessible metal parts of the enclosure.

Test Point 3: All sides.



SGS-CSTC Standards Technical Services Co., Ltd. Shenzhen Branch

SZEMC-TRF-01 Rev. A/0 Aug01,2022

Report No.: SZEM230600405101

Page: 45 of 64

Discharge type	Level (kV)	Polarity	Test Point	Result / Observations
Air Discharge	2,4,8	+	1	N/A
Air Discharge	2,4,8	-	1	N/A
Contact Discharge	4	+	2	N/A
Contact Discharge	4	-	2	N/A
Horizontal Coupling	4	+	3	A
Horizontal Coupling	4	-	3	A
Vertical Coupling	4	+	3	A
Vertical Coupling	4	-	3	A

A: No degradation in the performance of the EUT was observed

N/A: Not applicable.



Unless otherwise agreed in writing, this document is issued by the Company subject to its General Conditions of Service printed overleaf, available on request or accessible at <https://www.sgs.com/en/Terms-and-Conditions>. Attention is drawn to the limitation of liability, indemnification and jurisdiction issues defined therein. Any holder of this document is advised that information contained hereon reflects the Company's findings at the time of its intervention only and within the limits of Client's instructions, if any. The Company's sole responsibility is to its Client and this document does not exonerate parties to a transaction from exercising all their rights and obligations under the transaction documents. This document cannot be reproduced except in full, without prior written approval of the Company. Any unauthorized alteration, forgery or falsification of the content or appearance of this document is unlawful and offenders may be prosecuted to the fullest extent of the law. Unless otherwise stated the results shown in this test report refer only to the sample(s) tested and such sample(s) are retained for 30 days only.

Attention: To check the authenticity of testing /inspection report & certificate, please contact us at telephone: (86-755) 8307 1443, or email: CN.Doccheck@sgs.com

7.2 Radiated Immunity (80MHz-1GHz,1800MHz,2600MHz,3500MHz,5000MHz)

Test Requirement: EN 55035: 2017+A11:2020

Test Method: EN IEC 61000-4-3: 2020

7.2.1 Test Setup Diagram

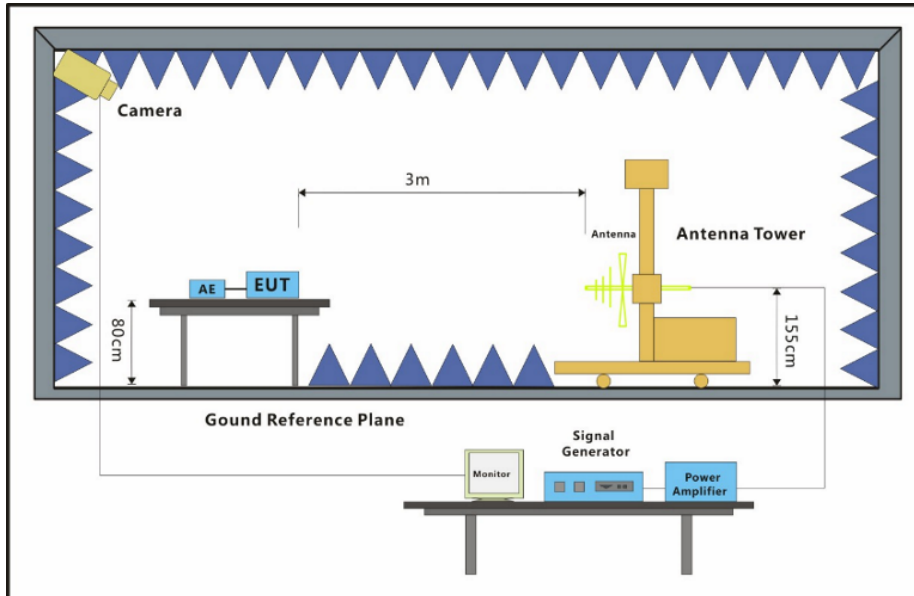

7.2.2 E.U.T. Operation

Operating Environment:

Temperature: 23.5 °C

Humidity: 48.9 % RH

Atmospheric Pressure: 1005 mbar

7.2.3 Test Mode Description

Pre-scan / Final test	Mode Code	Description
Final test	00	On mode, keep EUT working normally with test board.

7.2.4 Test Condition and Results:

Performance Criterion: A

Frequency Range: 80MHz to 1GHz, 1800MHz, 2600MHz, 3500MHz, 5000MHz

Antenna Polarisation: Vertical and Horizontal

Modulation: 1kHz,80% Amp. Mod,1% increment

Test Distance:3m



Unless otherwise agreed in writing, this document is issued by the Company subject to its General Conditions of Service printed overleaf, available on request or accessible at <https://www.sgs.com/en/Terms-and-Conditions>. Attention is drawn to the limitation of liability, indemnification and jurisdiction issues defined therein. Any holder of this document is advised that information contained hereon reflects the Company's findings at the time of its intervention only and within the limits of Client's instructions, if any. The Company's sole responsibility is to its Client and this document does not exonerate parties to a transaction from exercising all their rights and obligations under the transaction documents. This document cannot be reproduced except in full, without prior written approval of the Company. Any unauthorized alteration, forgery or falsification of the content or appearance of this document is unlawful and offenders may be prosecuted to the fullest extent of the law. Unless otherwise stated the results shown in this test report refer only to the sample(s) tested and such sample(s) are retained for 30 days only.

Frequency	Level (V/m)	EUT Face	Dwell time	Result / Observations
80MHz-1GHz	3	Front	3s	A
80MHz-1GHz	3	Back	3s	A
80MHz-1GHz	3	Left	3s	A
80MHz-1GHz	3	Right	3s	A
80MHz-1GHz	3	Top	3s	A
80MHz-1GHz	3	Underside	3s	A
1800MHz	3	Front	3s	A
1800MHz	3	Back	3s	A
1800MHz	3	Left	3s	A
1800MHz	3	Right	3s	A
1800MHz	3	Top	3s	A
1800MHz	3	Underside	3s	A
2600MHz	3	Front	3s	A
2600MHz	3	Back	3s	A
2600MHz	3	Left	3s	A
2600MHz	3	Right	3s	A
2600MHz	3	Top	3s	A
2600MHz	3	Underside	3s	A
3500MHz	3	Front	3s	A
3500MHz	3	Back	3s	A
3500MHz	3	Left	3s	A
3500MHz	3	Right	3s	A
3500MHz	3	Top	3s	A
3500MHz	3	Underside	3s	A
5000MHz	3	Front	3s	A
5000MHz	3	Back	3s	A
5000MHz	3	Left	3s	A
5000MHz	3	Right	3s	A
5000MHz	3	Top	3s	A
5000MHz	3	Underside	3s	A

A: No degradation in the performance of the EUT was observed



Unless otherwise agreed in writing, this document is issued by the Company subject to its General Conditions of Service printed overleaf, available on request or accessible at <https://www.sgs.com/en/Terms-and-Conditions>. Attention is drawn to the limitation of liability, indemnification and jurisdiction issues defined therein. Any holder of this document is advised that information contained hereon reflects the Company's findings at the time of its intervention only and within the limits of Client's instructions, if any. The Company's sole responsibility is to its Client and this document does not exonerate parties to a transaction from exercising all their rights and obligations under the transaction documents. This document cannot be reproduced except in full, without prior written approval of the Company. Any unauthorized alteration, forgery or falsification of the content or appearance of this document is unlawful and offenders may be prosecuted to the fullest extent of the law. Unless otherwise stated the results shown in this test report refer only to the sample(s) tested and such sample(s) are retained for 30 days only.

Attention: To check the authenticity of testing /inspection report & certificate, please contact us at telephone: (86-755) 8307 1443, or email: CN.Doccheck@sgs.com
 No.1 Workshop, M-10, Middle Section, Science & Technology Park, Nanshan District, Shenzhen, Guangdong, China 518057 t (86-755) 26012053 f (86-755) 26710594 www.sgs.com.cn
 中国·广东·深圳市南山区科技园中区M-10栋1号厂房 邮编: 518057 t (86-755) 26012053 f (86-755) 26710594 sgs.china@sgs.com

7.3 Electrical Fast Transients & Burst at AC Power Port

Test Requirement: EN 55035: 2017+A11:2020

Test Method: EN 61000-4-4: 2012

7.3.1 Test Setup Diagram

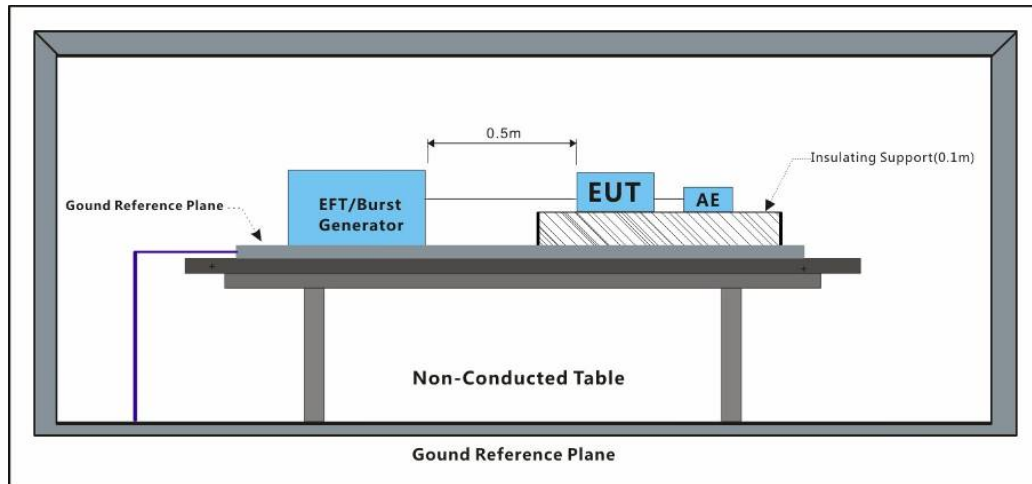

7.3.2 E.U.T. Operation

Operating Environment:

Temperature: 21.6 °C

Humidity: 59.4 % RH

Atmospheric Pressure: 1005 mbar

7.3.3 Test Mode Description

Pre-scan / Final test	Mode Code	Description
Final test	00	On mode, keep EUT working normally with test board.

7.3.4 Test Condition and Results:

Performance Criterion: B

Repetition Frequency: 5kHz

Burst Period: 300ms

Test Duration: 2 minute per level & polarity

Test Line	Level (kV)	Polarity	CDN/Clamp	Result / Observations
AC power port	1	+	CDN	A
AC power port	1	-	CDN	A

A: No degradation in the performance of the EUT was observed



7.4 Surge at AC Power Port

Test Requirement: EN 55035: 2017+A11:2020
 Test Method: EN 61000-4-5: 2014 +A1: 2017

7.4.1 Test Setup Diagram

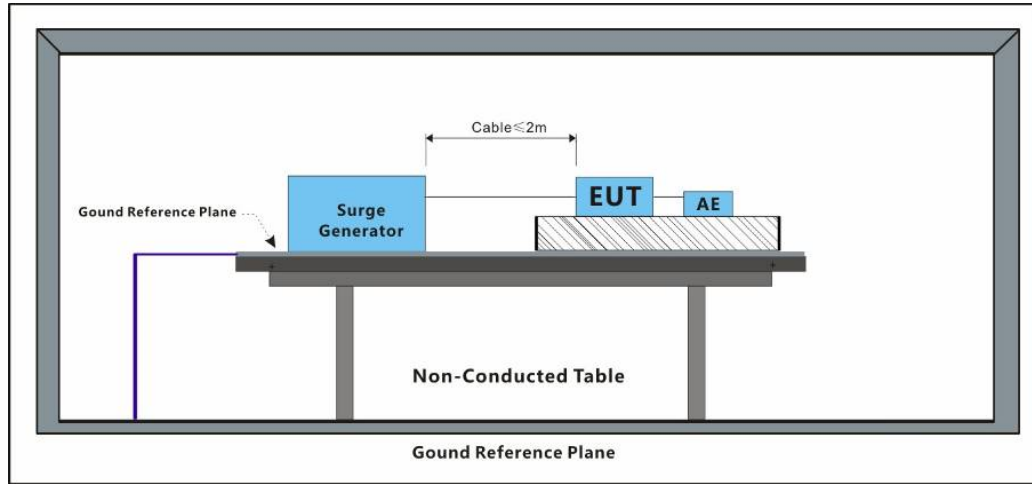

7.4.2 E.U.T. Operation

Operating Environment:
 Temperature: 21.6 °C Humidity: 59.4 % RH Atmospheric Pressure: 1005 mbar

7.4.3 Test Mode Description

Pre-scan / Final test	Mode Code	Description
Final test	00	On mode, keep EUT working normally with test board.

7.4.4 Test Condition and Results:

Performance Criterion: B
 Interval: 60s between each surge
 Generator source impedance: 2Ω
 CDN coupling impedance(Line-to-ground):10Ω
 No. of surges:
 Five positive pulses line-to-neutral at 90° phase
 Five negative pulses line-to-neutral at 270° phase
 Five positive pulses line-to-earth at 90° phase
 Five negative pulses line-to-earth at 270° phase
 Five negative pulses neutral-to-earth at 90° phase
 Five positive pulses neutral-to-earth at 270° phase



Unless otherwise agreed in writing, this document is issued by the Company subject to its General Conditions of Service printed overleaf, available on request or accessible at <https://www.sgs.com/en/Terms-and-Conditions>. Attention is drawn to the limitation of liability, indemnification and jurisdiction issues defined therein. Any holder of this document is advised that information contained hereon reflects the Company's findings at the time of its intervention only and within the limits of Client's instructions, if any. The Company's sole responsibility is to its Client and this document does not exonerate parties to a transaction from exercising all their rights and obligations under the transaction documents. This document cannot be reproduced except in full, without prior written approval of the Company. Any unauthorized alteration, forgery or falsification of the content or appearance of this document is unlawful and offenders may be prosecuted to the fullest extent of the law. Unless otherwise stated the results shown in this test report refer only to the sample(s) tested and such sample(s) are retained for 30 days only.
Attention: To check the authenticity of testing /inspection report & certificate, please contact us at telephone: (86-755) 8307 1443, or email: CN.Doccheck@sgs.com
 No.1 Workshop, M-10, Middle Section, Science & Technology Park, Nanshan District, Shenzhen, Guangdong, China 518057 t (86-755) 26012053 f (86-755) 26710594 www.sgsgroup.com.cn
 中国·广东·深圳市南山区科技园中区M-10栋1号厂房 邮编: 518057 t (86-755) 26012053 f (86-755) 26710594 sgs.china@sgs.com

SGS-CSTC Standards Technical Services Co., Ltd. Shenzhen Branch

SZEMC-TRF-01 Rev. A/0 Aug01,2022

Report No.: SZEM230600405101

Page: 50 of 64

Test Line	Level (kV)	Polarity	Phase (deg)	Result / Observations
Line to Neutral	0.5, 1	+	90°	A
Line to Neutral	0.5, 1	-	270°	A

A: No degradation in the performance of the EUT was observed



Unless otherwise agreed in writing, this document is issued by the Company subject to its General Conditions of Service printed overleaf, available on request or accessible at <https://www.sgs.com/en/Terms-and-Conditions>. Attention is drawn to the limitation of liability, indemnification and jurisdiction issues defined therein. Any holder of this document is advised that information contained hereon reflects the Company's findings at the time of its intervention only and within the limits of Client's instructions, if any. The Company's sole responsibility is to its Client and this document does not exonerate parties to a transaction from exercising all their rights and obligations under the transaction documents. This document cannot be reproduced except in full, without prior written approval of the Company. Any unauthorized alteration, forgery or falsification of the content or appearance of this document is unlawful and offenders may be prosecuted to the fullest extent of the law. Unless otherwise stated the results shown in this test report refer only to the sample(s) tested and such sample(s) are retained for 30 days only.

Attention: To check the authenticity of testing /inspection report & certificate, please contact us at telephone: (86-755) 8307 1443, or email: CN.Doccheck@sgs.com

7.5 Conducted Immunity at AC Power Port (150kHz-80MHz)

Test Requirement: EN 55035: 2017+A11:2020

Test Method: EN 61000-4-6: 2014

7.5.1 Test Setup Diagram

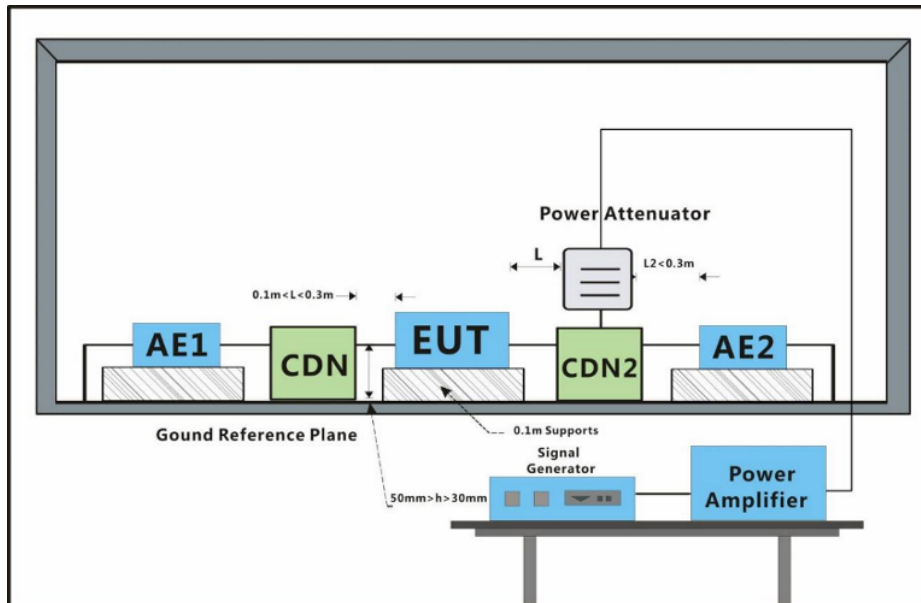

7.5.2 E.U.T. Operation

Operating Environment:

Temperature: 21.6 °C

Humidity: 59.4 % RH

Atmospheric Pressure: 1005 mbar

7.5.3 Test Mode Description

Pre-scan / Final test	Mode Code	Description
Final test	00	On mode, keep EUT working normally with test board.

7.5.4 Test Condition and Results:

Performance Criterion: A

Frequency Range: 0.15MHz to 80MHz

Modulation: 80%, 1kHz Amplitude Modulation

Step Size: 1%



SGS-CSTC Standards Technical Services Co., Ltd. Shenzhen Branch

SZEMC-TRF-01 Rev. A/0 Aug01,2022

Report No.: SZEM230600405101

Page: 52 of 64

Cable port	Level (Vrms)	CDN/Clamp	Dwell time	Result / Observations
AC power port	3(0.15MHz-10MHz)	CDN	3s	A
AC power port	3 to 1(10MHz-30MHz, Lines)	CDN	3s	A
AC power port	1(30MHz-80MHz)	CDN	3s	A

A: No degradation in the performance of the EUT was observed



Unless otherwise agreed in writing, this document is issued by the Company subject to its General Conditions of Service printed overleaf, available on request or accessible at <https://www.sgs.com/en/Terms-and-Conditions>. Attention is drawn to the limitation of liability, indemnification and jurisdiction issues defined therein. Any holder of this document is advised that information contained hereon reflects the Company's findings at the time of its intervention only and within the limits of Client's instructions, if any. The Company's sole responsibility is to its Client and this document does not exonerate parties to a transaction from exercising all their rights and obligations under the transaction documents. This document cannot be reproduced except in full, without prior written approval of the Company. Any unauthorized alteration, forgery or falsification of the content or appearance of this document is unlawful and offenders may be prosecuted to the fullest extent of the law. Unless otherwise stated the results shown in this test report refer only to the sample(s) tested and such sample(s) are retained for 30 days only.

Attention: To check the authenticity of testing /inspection report & certificate, please contact us at telephone: (86-755) 8307 1443, or email: CN.Doccheck@sgs.com

7.6 Voltage Dips and Interruptions

Test Requirement: EN 55035: 2017+A11:2020

Test Method: EN IEC 61000-4-11:2020

7.6.1 Test Setup Diagram

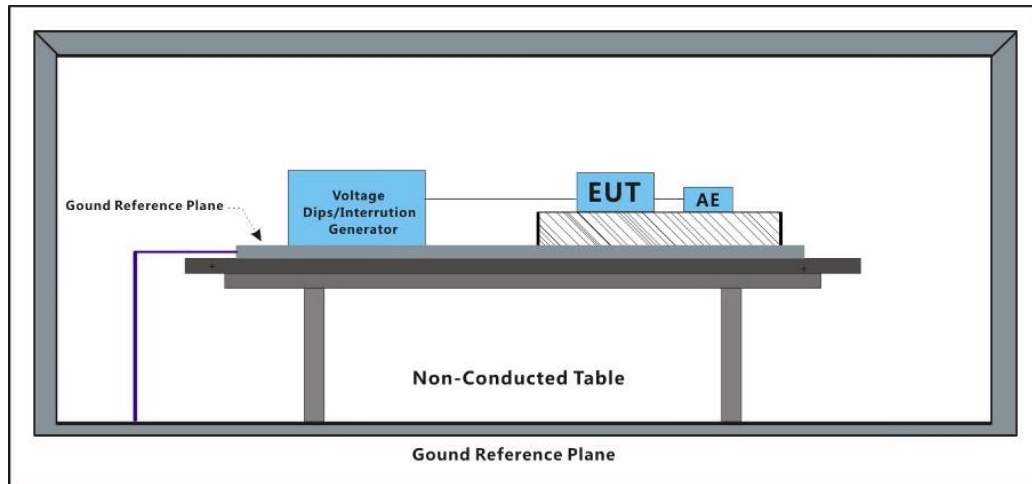

7.6.2 E.U.T. Operation

Operating Environment:

Temperature: 21.6 °C Humidity: 59.4 % RH Atmospheric Pressure: 1005 mbar

7.6.3 Test Mode Description

Pre-scan / Final test	Mode Code	Description
Final test	00	On mode, keep EUT working normally with test board.

7.6.4 Test Condition and Results:

Performance Criterion:

<5% residual voltage for 0.5 Cycle: B

70% residual voltage for 25 Cycles: C

<5% residual voltage for 250 Cycles: C

No. of Dips / Interruptions: 3 per Level

Time between dropout: 10s



Level % UT	Phase (deg)	Duration	No. of Dips / Interruptions	Result / Observations
0	0°	0.5 Cycles	3	A
0	0°	250 Cycles	3	C
70	0°	25 Cycles	3	A

A: No degradation in the performance of the EUT was observed

C: The EUT stop working during the test. It can be recovered by user after the test.



Unless otherwise agreed in writing, this document is issued by the Company subject to its General Conditions of Service printed overleaf, available on request or accessible at <https://www.sgs.com/en/Terms-and-Conditions>. Attention is drawn to the limitation of liability, indemnification and jurisdiction issues defined therein. Any holder of this document is advised that information contained hereon reflects the Company's findings at the time of its intervention only and within the limits of Client's instructions, if any. The Company's sole responsibility is to its Client and this document does not exonerate parties to a transaction from exercising all their rights and obligations under the transaction documents. This document cannot be reproduced except in full, without prior written approval of the Company. Any unauthorized alteration, forgery or falsification of the content or appearance of this document is unlawful and offenders may be prosecuted to the fullest extent of the law. Unless otherwise stated the results shown in this test report refer only to the sample(s) tested and such sample(s) are retained for 30 days only.

Attention: To check the authenticity of testing /inspection report & certificate, please contact us at telephone: (86-755) 8307 1443, or email: CN.Doccheck@sgs.com

8 Test Setup Photo

Conducted Emissions at Mains Power Port (150kHz-30MHz)

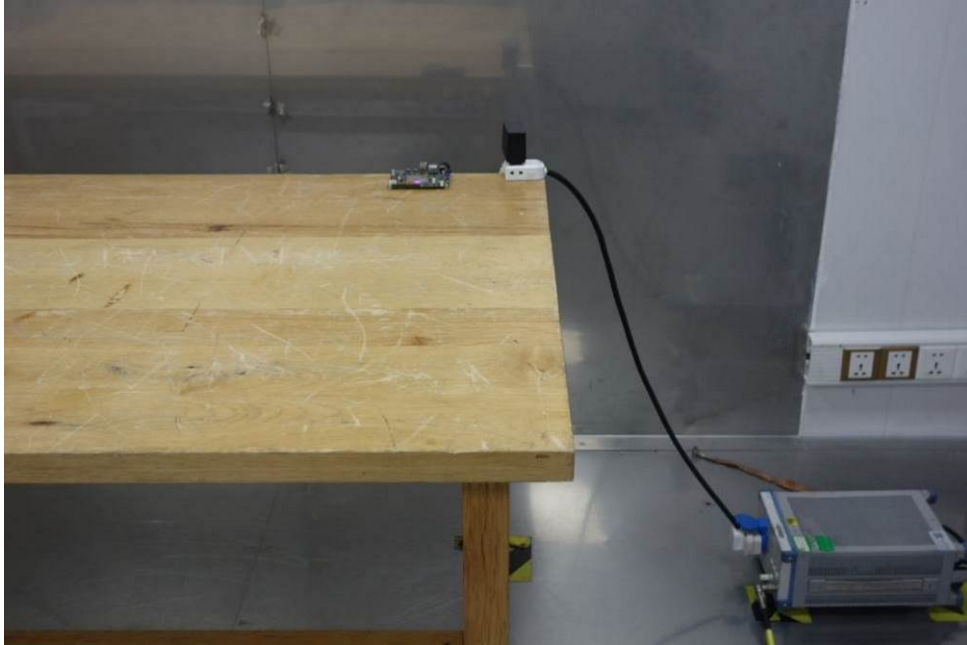

Radiated Emissions (30MHz-1GHz)

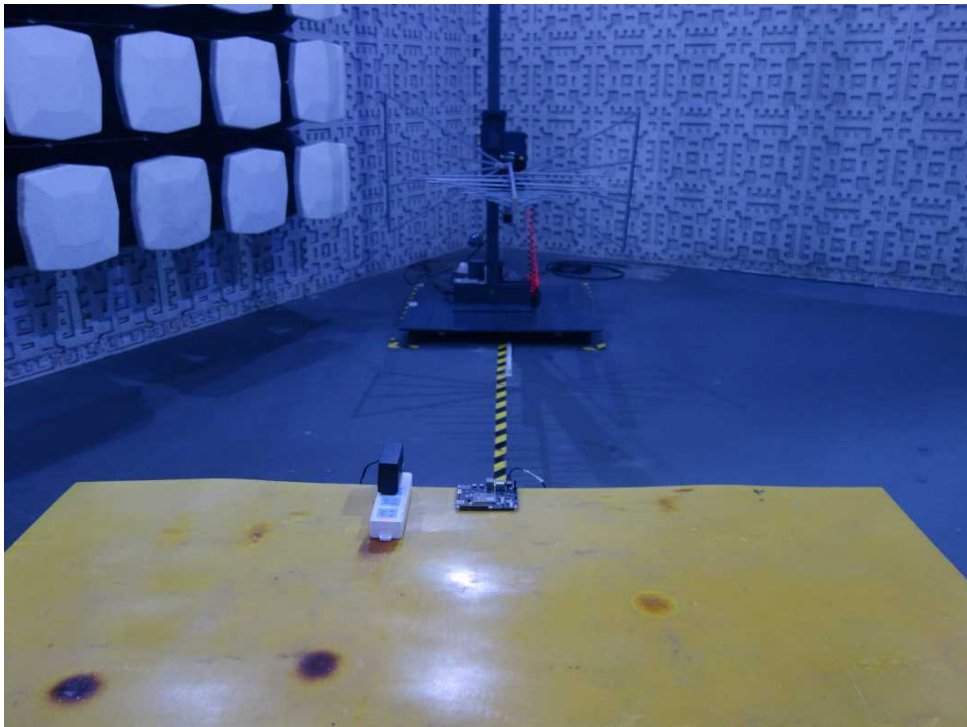

Radiated Emissions (Above 1GHz)

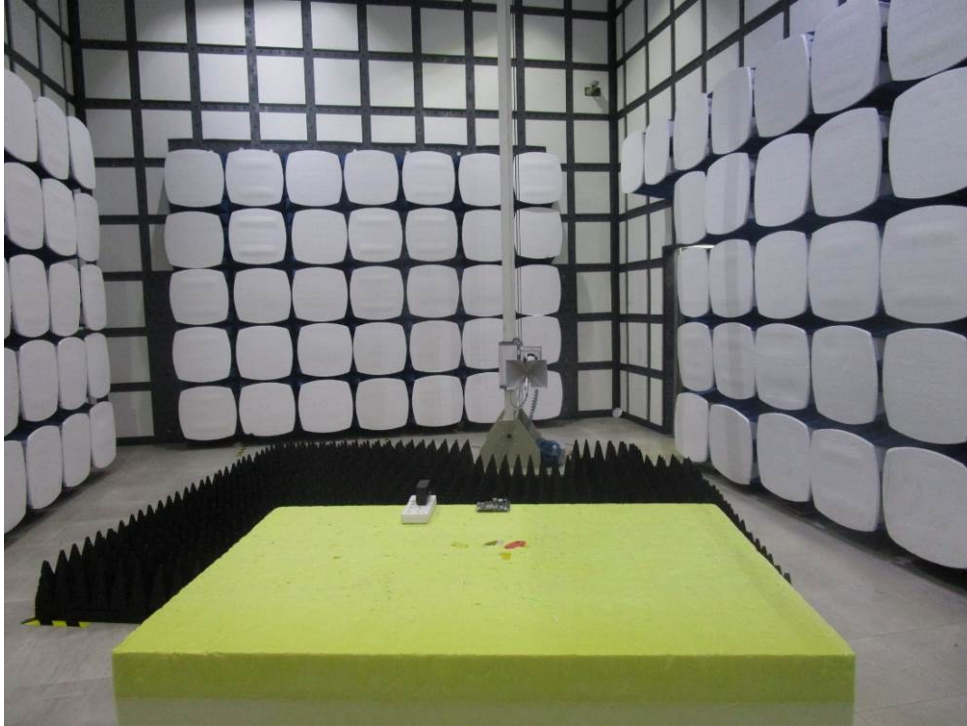

Voltage Fluctuations and Flicker

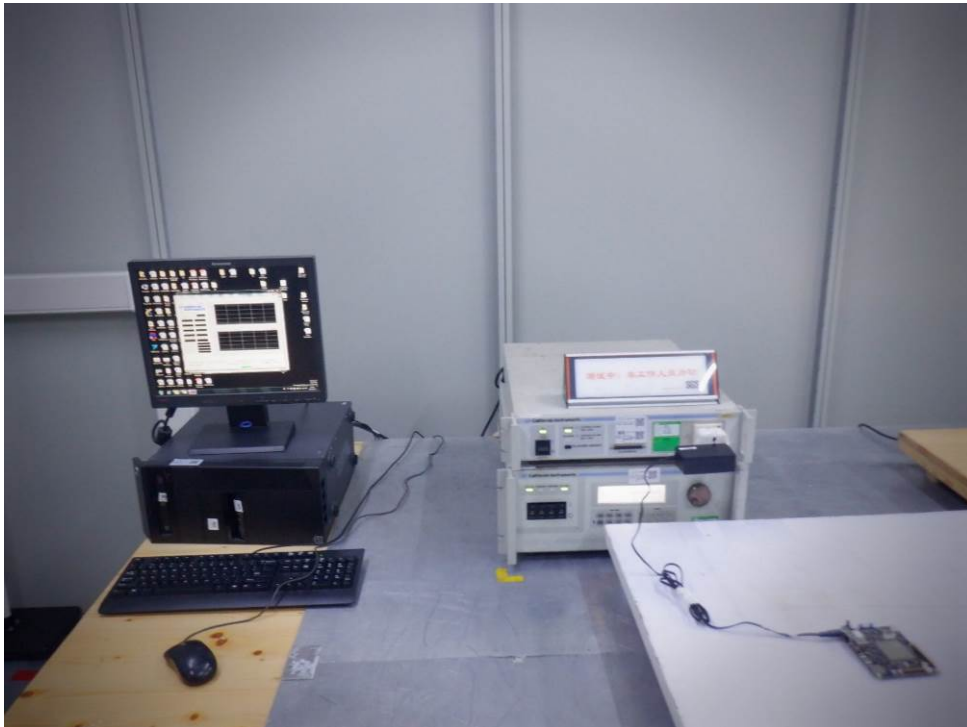

Electrostatic Discharge



Radiated Immunity (80MHz-1GHz,1800MHz,2600MHz,3500MHz,5000MHz)

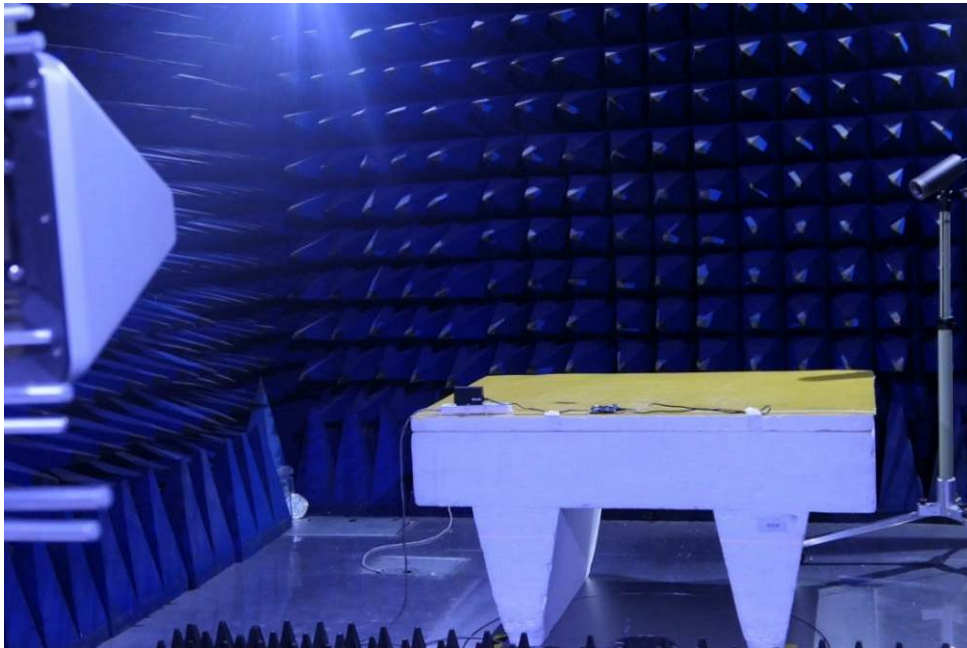

Electrical Fast Transients & Burst at AC Power Port

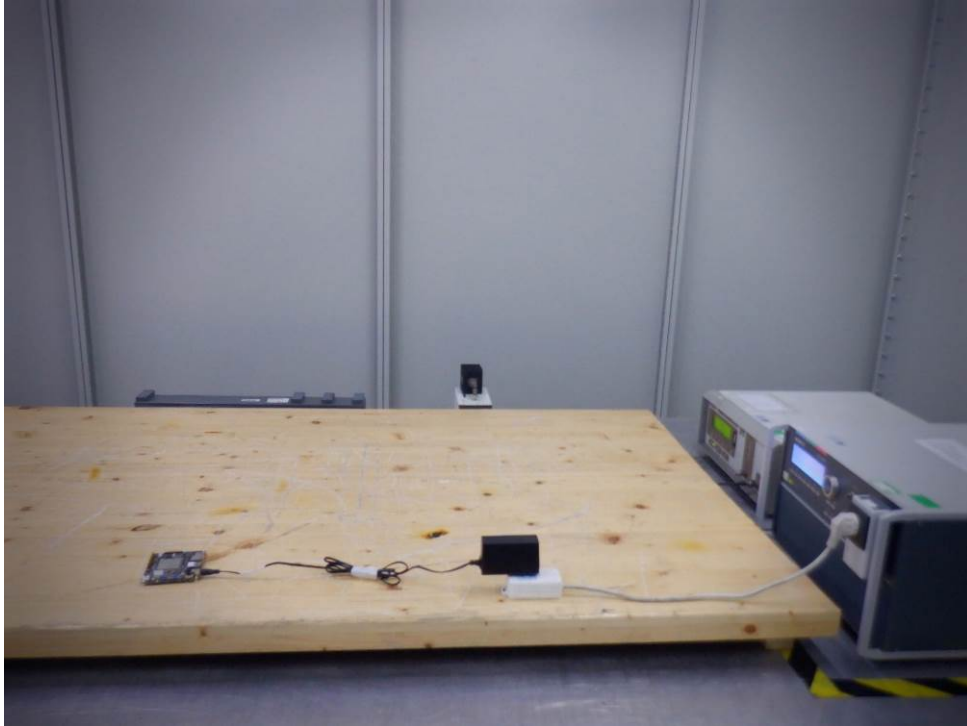

Surge at AC Power Port

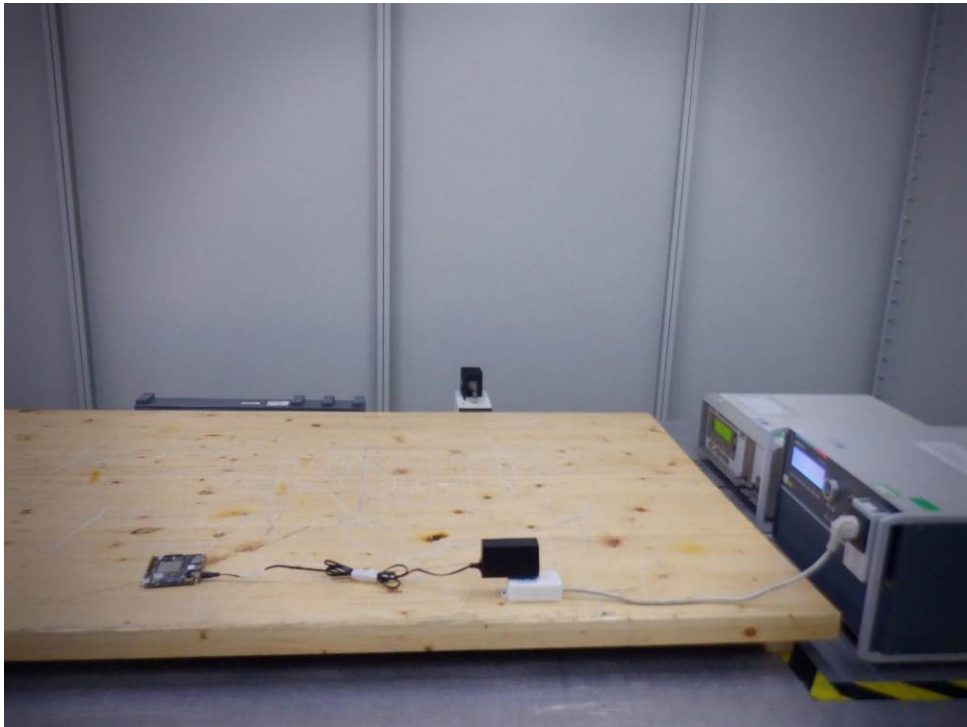

Conducted Immunity at AC Power Port (150kHz-80MHz)

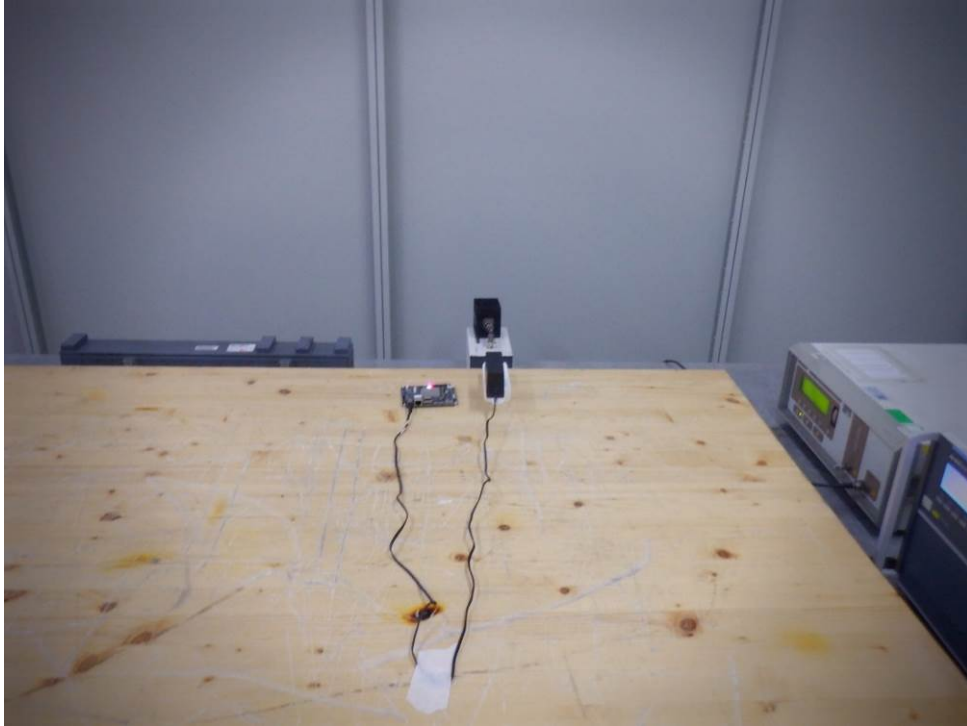

Voltage Dips and Interruptions

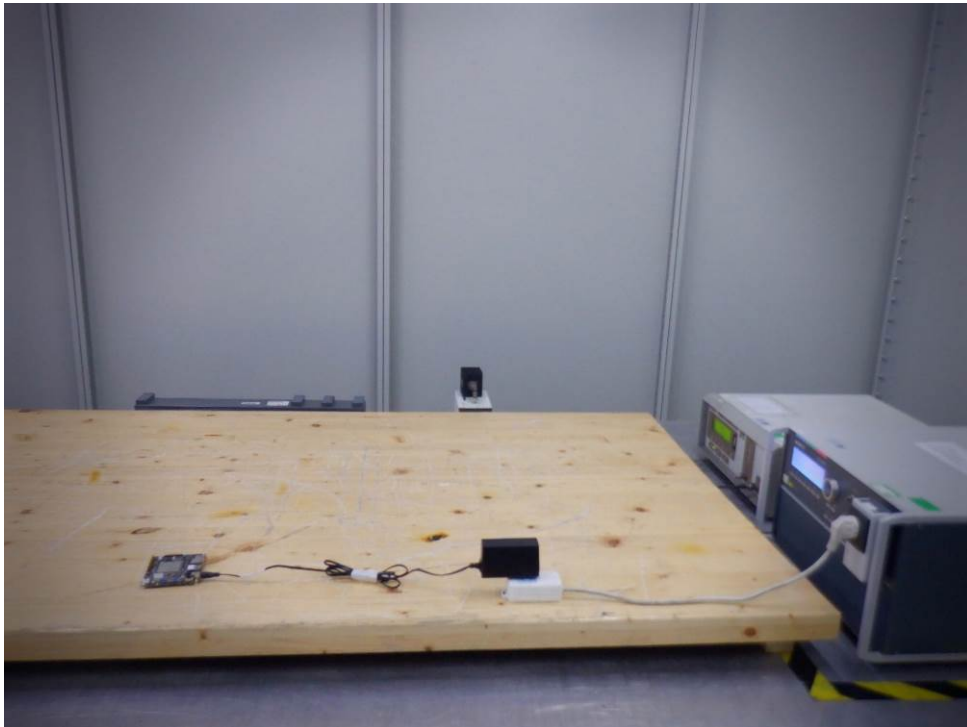

9 EUT Constructional Details (EUT Photos)



Unless otherwise agreed in writing, this document is issued by the Company subject to its General Conditions of Service printed overleaf, available on request or accessible at <https://www.sgs.com/en/Terms-and-Conditions>. Attention is drawn to the limitation of liability, indemnification and jurisdiction issues defined therein. Any holder of this document is advised that information contained hereon reflects the Company's findings at the time of its intervention only and within the limits of Client's instructions, if any. The Company's sole responsibility is to its Client and this document does not exonerate parties to a transaction from exercising all their rights and obligations under the transaction documents. This document cannot be reproduced except in full, without prior written approval of the Company. Any unauthorized alteration, forgery or falsification of the content or appearance of this document is unlawful and offenders may be prosecuted to the fullest extent of the law. Unless otherwise stated the results shown in this test report refer only to the sample(s) tested and such sample(s) are retained for 30 days only.

Attention: To check the authenticity of testing /inspection report & certificate, please contact us at telephone: (86-755) 8307 1443, or email: CN.Doccheck@sgs.com



Unless otherwise agreed in writing, this document is issued by the Company subject to its General Conditions of Service printed overleaf, available on request or accessible at <https://www.sgs.com/en/Terms-and-Conditions>. Attention is drawn to the limitation of liability, indemnification and jurisdiction issues defined therein. Any holder of this document is advised that information contained hereon reflects the Company's findings at the time of its intervention only and within the limits of Client's instructions, if any. The Company's sole responsibility is to its Client and this document does not exonerate parties to a transaction from exercising all their rights and obligations under the transaction documents. This document cannot be reproduced except in full, without prior written approval of the Company. Any unauthorized alteration, forgery or falsification of the content or appearance of this document is unlawful and offenders may be prosecuted to the fullest extent of the law. Unless otherwise stated the results shown in this test report refer only to the sample(s) tested and such sample(s) are retained for 30 days only.

Attention: To check the authenticity of testing /inspection report & certificate, please contact us at telephone: (86-755) 8307 1443, or email: CN.Doccheck@sgs.com

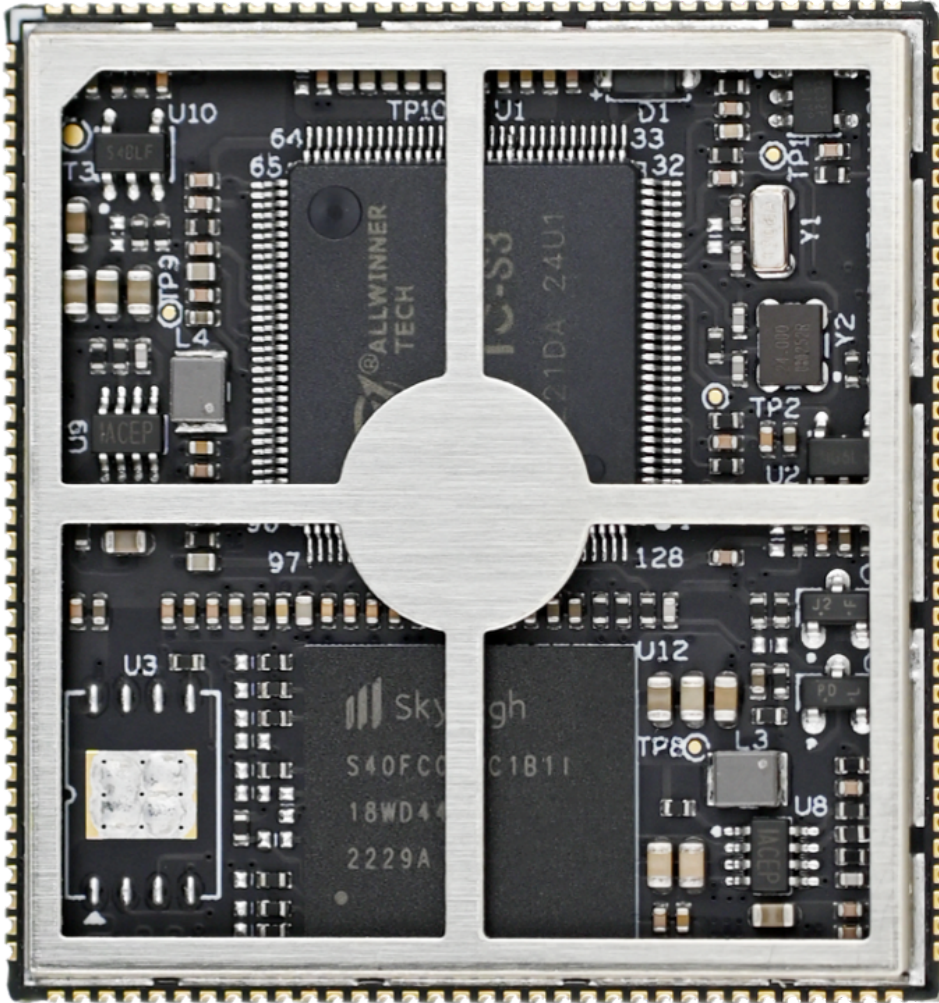

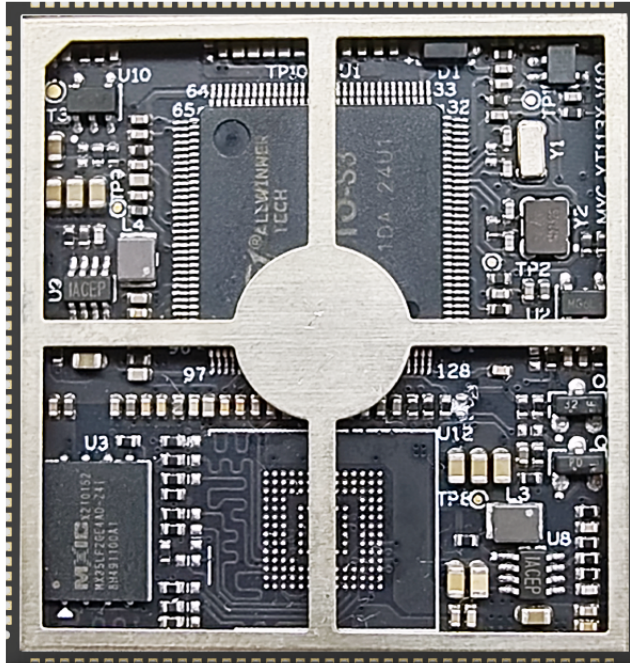

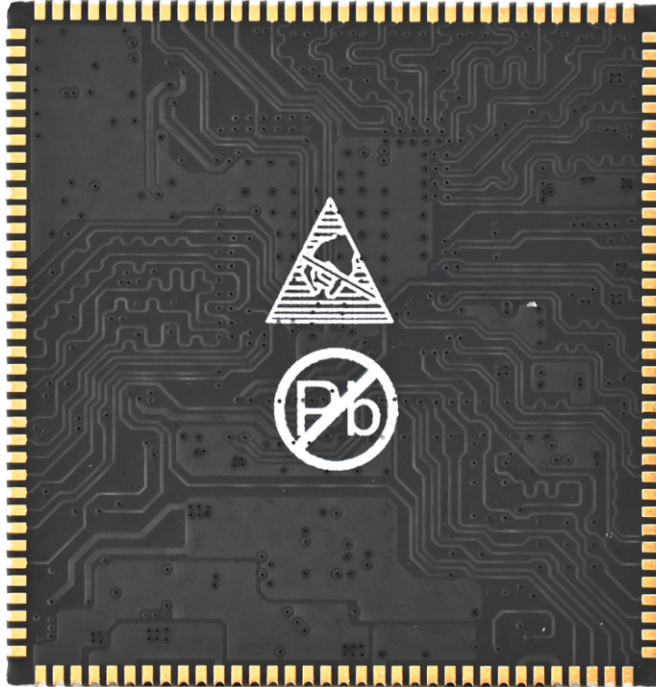

- End of the Report -

